

DRUK GREEN POWER CORPORATION LIMITED



BIDDING DOCUMENT FOR CONSTRUCTION OF BOAT SHED AND EXTERNAL WALL REPAINTING OF POWER HOUSE

TENDER NO.: KHP0003/2024

DATE: 21/03/2024

(DOMESTIC COMPETITIVE BIDDING)

TABLE OF CONTENTS

NOTICE INVITING TENDER	4
SECTION I - INSTRUCTION TO BIDDERS	7
ITB.1. Bidding Documents	7
ITB.2. Fraud and Corruption	7
ITB.3. Eligible Bidders	8
ITB.4. Exclusion of Bidders	9
ITB.5. Amendment of Bidding Documents	9
ITB.6. Clarification on Bidding Document	10
ITB.7. Language of Bid	10
ITB.8. Site Visit	10
ITB.9. Cost of Bid Preparation	10
ITB.10. Modification and Withdrawal of Bids	10
ITB.11. Bid Prices and Discount	11
ITB.12. Correction of Arithmetical Errors in the Price Bid	11
ITB.13. Period of Validity of Bids	12
ITB.14. Currency of Bid	12
ITB.15. Bid Security	13
ITB.16. Documents Comprising the Bids	13
ITB.17. Signing of Bids	14
ITB.18. Submission of Bids	14
ITB.19. Opening of Bid	14
ITB.20. Bid Evaluation	15
ITB.21. Contacting the DGPC	16
ITB.22. Award Criteria	16
ITB.23. Deviations:	16
ITB.24. Notification of Award:	17
ITB.25. Debriefing by DGPC	17
ITB.26. Retention Money	18
ITB.27. Performance Evaluation of Contractor	18
SECTION II- BID DATA SHEET	20
SECTION III- BIDDING FORMS	24
Form 1: Bid Security (Bank Guarantee)	24
Form 2A: Deviation Schedule of Technical Bid	25

Form 2B: Deviation Schedule of Financial Bid	26
Form 3A: Technical Bid Submission Form	27
Form 3B: Financial Bid Submission Form	29
Form 4: Power of Attorney	30
Form 5: Certificate Regarding Acceptance of Important Conditions	32
Form 6: Bill of Quantities	33
Form 7: Performance Evaluation System Acceptance	44
SECTION IV- GENERAL CONDITIONS OF CONTRACT	46
GCC.1. Definition	46
GCC.2. Language	46
GCC.3. Governing Law	47
GCC.4. Compliance with Law	47
GCC.5. Fraud and Corruption	47
GCC.6. Contractor's Responsibilities	48
GCC.7. DGPC's Responsibilities	48
GCC.8. Welfare of Labour and Child Labour	48
GCC.9. Safety	48
GCC.10. Quality Assurance Plan	49
GCC.11. Property	49
GCC.12. Insurance	49
GCC.13. Possession of the Site	49
GCC.14. Commencement of Work	49
GCC.15. Completion of Work	49
GCC.16. Programme of Work	49
GCC.17. Compensation Events	49
GCC.18. Contract Price	50
GCC.19. Payment Certificates	50
GCC.20. Terms of Payment	50
GCC.21. Taxes and Duties	50
GCC.22. Subcontracting	51
GCC.23. Retention Money	52
GCC.24. Liquidated Damages for delay	52
GCC.25. Defect Liability	52
GCC.26. Limitations of Liability	53

GCC.27.	Force Majeure	53
GCC.28.	Variation	54
GCC.29.	Termination	58
GCC.30.	Payment upon Termination	58
GCC.31.	Sub- Letting	59
GCC.32.	Taking Over	59
GCC.33.	Settlement of Disputes	59
SECTION V- SPECIAL CONDITIONS OF CONTRACT		61
TECHNICAL SPECIFICATION		63
1.	Drawings	64
SECTION VII- CONTRACT FORM		71
	Form 1: Contract Agreement	71
	Form 2: Letter of Award of Contract	72
SECTION VIII - PERFORMANCE EVALUATION SYSTEM		74
1.	INTRODUCTION	74
2.	OBJECTIVES	74
3.	PERFORMANCE EVALUATION SYSTEM (PES)	74
3.1	Pre-construction (10%)	74
3.2	Construction (80%)	75
3.3	Completion Time (10%)	78
4.	Contractor Assessment Category	78
5.	EVALUATION PERIOD AND DEBARMENT	78
5.1.	Evaluation period	78
5.2.	Debarment of Contractors	78

KURICHHU HYDROPOWER PLANT
 TECHNICAL SUPPORT UNIT
 GYALPOIZHING, MONGAR

NOTICE INVITING TENDER

For

Construction of Boat Shed and External Wall Repainting of Power House

Tender No: **KHP0003/2024**

Date: 21/03/2024

1. The Kurichhu Hydropower Plant, Technical Support Unit (TSU) of DGPC, invites sealed bids from eligible Bidders meeting the Qualification Requirements for the construction of **Construction of Boat Shed and External Wall Repainting of Power House** as per the scope of work mentioned hereinafter.
2. Detailed specifications, the scope of work, and terms and conditions of Works are given in the Bidding Documents.
3. The Bids will be received as per the following schedule:

NIT No and name of the Works	:	NIT No.: KHP0003/2024. Name of the Work: Construction of Boat Shed and External Wall Repainting of Power House.
Last date for Bid receipt & time and place of receipt	:	Up to: 05/04/2024 by 14:30 at the address.
Bid opening date & time and place	:	On 05/04/2024 at 15:00 at Kurichhu Hydropower Plant, Gyalpoizhing.
The Name and address of the contact person for seeking Clarifications on the Bid Documents	:	Tandin Wangchuk, Head, Civil Maintenance Unit, KHP Tele#04-744115/17650995 Up to 04.04.2024 Time: 16:30 hrs

4. Bidding documents shall be downloaded from DGPC website (www.drukgreen.bt) free of cost. Bidders downloading the documents from the website should register themselves by



- informing the nodal officer of DGPC immediately after the documents are downloaded or, before the date deadline for submission of the Bid and their intention to submit the Bid.
5. Downloading of Bidding Documents shall not automatically construe that the Bidder fulfils the Qualifying Requirements, which shall be determined during Bid evaluation based on data/documents submitted by the Bidder. Bids shall be submitted at the address given in the table above and shall be opened in the presence of Bidder's representatives who choose to attend.
 6. All Bids must be accompanied by Bid security for an amount of **BTN 38,000.00(Ngultrum Thirty-Eight Thousand)** in the form of Demand Draft /Cash Warrant /Banker's Cheque/ Bank Guarantee, issued by any financial institutions as acceptable to DGPC and shall remain valid till **05/07/2024**. Bids not accompanied with an acceptable Bid security as specified in Bidding Documents, or Bids accompanied with Bid security of inadequate value and validity shall be rejected by DGPC and in such cases Bids shall be returned to the Bidders.
 7. Qualification Requirement for Bidders shall be as specified in the BDS.
 8. No request for sending the Bidding Documents by post or by Courier Service shall be entertained. Bid Documents are not transferable.
 9. DGPC reserves the right to accept or reject any Bid partly or fully or cancel the bidding process without assigning any reasons thereof and in such case no Bidder/intending Bidder shall have any claim arising out of such action of DGPC.
 10. The Bidders shall be required to complete the Works within **6 months** from the date of contract agreement.
 11. Address for Communication:

Tshewang Namgyel
Head, Technical Support Unit,
Kurichhu Hydropower Plant
Druk Green Power Corporation Limited,
Gyalpoizhing, Mongar, Bhutan.
Phone No. 00975 4 744145 Extn. 4401
E-mail: t.namgyel837@drukgreen.bt



SECTION I - INSTRUCTION TO BIDDERS



SECTION I - INSTRUCTION TO BIDDERS

ITB.1. Bidding Documents

ITB.1.1. The detailed scope of construction of Works with technical specifications, Bidding procedures and contract terms are prescribed in the Bidding Document. This Bidding Document includes the following:

- a. Notice Inviting Tender;
- b. Instruction to Bidders;
- c. Bidding Forms;
- d. General Conditions of Contract;
- e. Technical Specifications;
- f. Contract Forms.

All these documents collectively or separately referred to as Bid Documents.

ITB.1.2. The Bidder is expected to examine all instructions, forms, terms and specifications in the Bid Document. Failure to furnish all information required as per the Bid Document or submission of a Bid not substantially responsive to the Bid Document in every respect will be at the Bidder's risk & responsibility and may result in rejection of their Bid.

ITB.2. Fraud and Corruption

ITB.2.1. DGPC requires that the Bidders, Contractors and their Subcontractors and their respective employees, consultants & agents, shall observe the highest standards of ethics during the Bidding process and execution of contracts.

ITB.2.2. For the purpose of the above sub-clause:

- a. "Corrupt practice" is the offering, giving, receiving or soliciting, directly or indirectly, of anything of value to influence improperly the actions of another party
- b. "Fraudulent practice" is any act or omission, including a misrepresentation, that knowingly or recklessly misleads, or attempts to mislead, a party to obtain a financial or other benefit or to avoid an obligation;
- c. "collusive practice" is an arrangement between two or more parties designed to achieve an improper purpose, including to influence improperly the actions of another party;
- d. coercive practice" is impairing or harming, or threatening to impair or harm, directly or indirectly, any party or the property of the party to influence improperly the actions of a party;
- e. "obstructive practice" is



- Deliberately, destroying, falsifying, altering or concealing of evidence material to the investigation or making false statements to investigators in order to materially impede any investigation into allegations of a corrupt, fraudulent, coercive or collusive practice; and/or threatening, harassing or intimidating any party to prevent it from disclosing its knowledge of matters relevant to the investigation or from pursuing the investigation, or
 - Acts intended materially to impede the exercise of the inspection rights of DGPC or any organization or person appointed by DGPC

ITB.2.3. DGPC will reject a Bid for award if it determines that the Bidder recommended for award has, directly or through an agent, engaged in corrupt, fraudulent, collusive, coercive or obstructive practices in competing for the Contract in question;

ITB.2.4. DGPC will declare the Bidder ineligible, either indefinitely or for a stated period of time for award of any Contract, if at any time it determines that the Bidder has, directly or through an agent, engaged in corrupt, fraudulent, collusive, coercive or obstructive practices in competing for, or in executing, a Contract.

ITB.2.5. DGPC will report any case of corrupt, fraudulent, collusive, coercive or obstructive practice to the relevant agencies, including but not limited to the Anti-corruption Commission (ACC) of the Kingdom of Bhutan, for necessary action in accordance with the statutes and provisions of the relevant agency.

ITB.3. Eligible Bidders

ITB.3.1. A Bidder shall be an incorporated legal entity A Bidder, shall have the nationality of only Bhutan, A Bidder shall be deemed to have the nationality of Bhutan if the Bidder is constituted, incorporated, or registered and operates in conformity with the provisions of the laws of Bhutan. This criterion shall also apply to the determination of the nationality of the proposed Subcontractors for any part of the Contract.

ITB.3.2. A Bidder shall not have conflict of interest. Any Bidder, found to have a conflict of interest, shall be disqualified. Bidders may be considered to have a conflict of interest with one or more parties in the same Bidding process if they:

- a. or any of their affiliates are associated, or have been associated in the past, to provide consulting services for the preparation of the design, specifications and/or other documents to be used for the procurement of the Works to be executed pursuant to these Bidding Documents, or in any other way provided the consulting services in any aspect of the preparatory stages leading up to the issue of these Bidding Documents or hired/ proposed to be hired by DGPC as Project Manager for the Contract implementation
- b. Submit more than one Bid in this Bidding process. Participation by a Bidder in more than one Bid shall result in rejection of all Bids in which the Bidder has participated. However, this does not limit the participation of a Bidder as a Subcontractor in another Bid or more than one Bid, or
- c. Bidders otherwise engage, either directly or through any of their Affiliates, a DGPC employee, his spouse or any of the dependent parents or close



relatives of a DGPC employee. For the purposes of this sub-paragraph, a close relative is defined as immediate family which includes, brother, sister, and own children, or

- d. have the same legal authorised representative for purposes of this Bid.

ITB.4. Exclusion of Bidders

ITB.4.1. A Bidder shall be ineligible for participating in this Bidding process under the following circumstances:

- a. The Bidders is insolvent or is in receivership or is a bankrupt or is in the process of being wound up; or has entered into an arrangement with the creditors; or
- b. The Bidders' affairs are being administered by a court, judicial officer or appointed liquidator; or
- c. The Bidder has suspended business or is in any analogous situation arising from similar procedures under the laws and regulations of the kingdom of Bhutan; or
- d. The Bidder has been found guilty of professional misconduct by any competent authority as per law or any professional body; or
- e. Have at least one controlling shareholder in common;
- f. Have received any direct or indirect subsidy from either party;
- g. have a relationship with each other, directly or through common third parties, that puts them in a position to have access to information about or influence on the Bid of another Bidder, or influence the decisions of the Employer regarding this Bidding process;
- h. The Bidder has not fulfilled his obligations with regard to the payment of taxes, social security or other payments due in accordance with the laws of the Kingdom of Bhutan; or
- i. The Bidder has been declared by DGPC to be ineligible for participation in tenders on account of any fraud and/or corruption in competing or executing a Contract; or
- j. The Bidder has been debarred from participation in public procurement in the kingdom of Bhutan by any competent authority as per law.

ITB.5. Amendment of Bidding Documents

ITB.5.1. At any time prior to the deadline for submission of Bids, the DGPC may, for any reason, whether at its own initiative or in response to a clarification requested by a prospective Bidder, modify the Bid Document through an Addendum.

ITB.5.2. The Addendum, if any, shall be available for downloading from DGPC's website by prospective Bidders. The DGPC may, at its discretion, extend the deadline for Bid submission, if the Bidders are expected to require additional time in which to take the Addendum into account in preparation of their Bid or for any other reason. The



addendum shall be sent in writing to all the prospective bidders who have registered with DGPC for the work or to whom the Bid Document has been issued.

ITB.6. Clarification on Bidding Document

- ITB.6.1. The Bidder shall examine the Bidding Documents thoroughly in all respects and if any conflict, discrepancy, error or omission is observed, Bidder may request clarification promptly. A prospective Bidder requiring any clarification on Bidding Documents may notify DGPC in writing, to the address specified in BDS, not later than the date and time specified therein
- ITB.6.2. DGPC will issue clarification(s) as it may think fit in writing. All such clarifications shall form part of the Bidding Documents and shall accompany the Bidder's Proposal. Copies of DGPC's response (including an explanation of the query but without identifying its source) will be sent to all prospective Bidders who have registered with DGPC for the work or to whom the Bid Documents are issued.
- ITB.6.3. For the information of Bidders, the clarifications shall be uploaded on the website. The Bidders are advised to visit the website of the DGPC from time to time in their own interest. DGPC in no way be responsible for any ignorance on the part of the Bidders not to have visited the website and not taken into account any clarification or amendment into consideration while preparing their Bid.
- ITB.6.4. Bidders shall not be allowed to seek any clarification of the Bidding Documents in person or by telephone or other verbal means. Any queries sent by the Bidders after the date and time notified in the NIT or extended date, if any, shall not be entertained.

ITB.7. Language of Bid

- ITB.7.1. The Bid, and all correspondence and documents related to the Bid shall be in English. Additional/supporting documents provided by the Bidder related to the Bid shall be in English and if in any other language should be translated to English. The English translation shall prevail for the purpose of Bid interpretation.

ITB.8. Site Visit

- ITB.8.1. The Bidders, at their own responsibility and risk, are encouraged to visit and examine the Site and obtain all information that may be necessary for preparing the bid and entering into a Contract for performance of the Works. The costs of visiting the Site shall be at the bidder's own expense.

ITB.9. Cost of Bid Preparation

- ITB.9.1. Bidders shall bear all costs associated with the preparation and submission of Bid. DGPC, will in no case be responsible or liable for those costs, regardless of the conduct or outcome of the Bidding process.

ITB.10. Modification and Withdrawal of Bids

- ITB.10.1. The Bidder, on submission of written application, may modify or withdraw its Bid after the Bid's submission but prior to the deadline for submission of Bid.
- ITB.10.2. No Bid can be modified subsequent to the deadline for submission of Bids.



ITB.10.3. No Bid will be withdrawn in the interval between the deadline for submission of Bid and expiration of the period of the Bid validity or any extension thereof.

ITB.11. Bid Prices and Discount

ITB.11.1. The Bidder shall fill in unit rates/ prices for all items of the Works described in the Bill of Quantities in figures and words. The unit rates/ prices quoted in the Bill of Quantities shall also be deemed to include any incidentals not shown or specified but reasonably implied or necessary for the proper completion and functioning of the whole specified item of the Works in accordance with the Bidding Documents and shall also deemed to include the cost of construction of infrastructural facilities required for execution of the Contract and not included in the Works. The Contract shall be for the whole Works based on the unit rates and prices in the Priced Bill of Quantities submitted by the Bidder.

ITB.11.2. The unit rates/ prices quoted in the Bill of Quantities shall be inclusive of all the cost of materials, transportation, labour, taxes, duties, levies & charges payable in the Kingdom of Bhutan as of thirty (30 days) days prior to the deadline for submission of Bids, overhead and profit and any other costs.

ITB.11.3. The total price at the bottom of the Priced Bill of Quantities shall be indicated both in figures and words.

ITB.11.4. The rebate/discount if any offered, in percentage shall be brought out in the Priced Bill of Quantities. Conditional rebates/discount, if any, offered by any Bidder shall not be considered during Bid evaluation.

ITB.11.5. Items for which no rate or price is entered by the Bidder in the Priced Bill of Quantities shall not be paid by DGPC when executed and shall be deemed covered by the other rates and prices mentioned in the Priced Bill of Quantities.

ITB.11.6. Bidders participating from India, for supply and bonafide use in the Kingdom of Bhutan shall quote the rates and prices for the items in the Bill of Quantities exclusive of any effect of the Integrated Goods and Service Tax (IGST). The IGST on the export of goods or services or both are covered under Zero Rated Supply as per Chapter VII, 16(1) THE INTEGRATED GOODS AND SERVICES TAX ACT, 2019 of India.

ITB.12. Correction of Arithmetical Errors in the Price Bid

ITB.12.1. Arithmetical errors will be corrected at the time of evaluation of Price Bid and the corrected figure will be considered as evaluated Bid price. The corrections in the Bid price shall be done as per the provisions of this clause and shall be binding on the Bidder. If the Bidder does not accept the correction of errors as per the provisions of this clause the Bid will be rejected, and the Bid Security will be forfeited.

ITB.12.2. If there is a discrepancy between the product of unit price and quantity for each item, and the total price, the unit price and quantity will prevail and the total price shall be corrected unless in the opinion of the DGPC there is an obviously gross misplacement of decimal point in the unit rate, or ignoring to put any zero or putting any extra Zero in the unit price in which case, the total of line item as quoted will govern and unit rate will be corrected accordingly.



- ITB.12.3. If there is discrepancy between summation of subtotals and total price, the summation of subtotal price shall prevail, and the total price shall be corrected.
- ITB.12.4. If there is a discrepancy between words and figure of the total price for each item wherever the Bid Document requires the figures to be written in both words and figures the amount in words will prevail unless the amount expressed in word has an arithmetic error.
- ITB.12.5. In case the Bidder has not filled up unit price against any item, the DGPC shall treat the price of unfilled items as zero for the purpose of evaluation comparison and award (if such Bidder emerges as the lowest evaluated Bidder), with the assumption that the cost have been absorbed elsewhere in the Price Bid.
- ITB.12.6. In case price for any specific item is given by a Bidder as lump sum instead of unit rates as required, the DGPC reserves the right to arrive at unit rate on the basis of dividing the quoted lump sum amount by the specified quantity in the Bill of Quantities. In case of multiple items if the Bidder has quoted a lump sum price, in the event such Bidder is declared successful, the break-up of unit prices shall be discussed and agreed during the pre-award discussions with the Bidder subject to the lump-sum amount as quoted by the Bidder, and the break-up as agreed shall form part of the Letter of Award.

ITB.13. Period of Validity of Bids

- ITB.13.1. Bids shall remain valid for a period as specified in the BDS. A Bid valid for a shorter period shall be rejected by the DGPC as non-responsive.
- ITB.13.2. In exceptional circumstances, prior to expiry of the Bid validity, the DGPC may request Bidders to extend the period of validity of their Bids. The request and the responses shall be made in writing. The Bid Security shall be extended for a corresponding period. A Bidder may refuse the request to extend the validity of its Bids without forfeiting its Bid Security. A Bidder granting request shall not be required or permitted to modify its Bids.

ITB.14. Currency of Bid

- ITB.14.1. The unit rates and prices shall be quoted by the Bidder in the local currency except in case of international Bidders. The currencies shall be any one of the currencies out of those specified in the BDS.
- ITB.14.2. The rates of exchange to be used for conversion into Bhutanese Ngultrum (BTN) for evaluation and comparison, shall be the reference rates on the date of Bid opening or immediate preceding date if rate of exchange for the date of Bid opening is not available. The reference exchange rate (selling rate) prevailing at that date as posted by the Royal Monetary Authority of the Kingdom of Bhutan shall be used for the conversion of prices.
- ITB.14.3. The Bids shall be evaluated in accordance with ITB.20 above, but the payment shall be made in the currency of Bid.
- ITB.14.4. Notwithstanding the provision contained in clause ITB.14.1 Indian Bidders must quote the unit rates in INR only.



ITB.15. Bid Security

- ITB.15.1. The Bidder shall furnish, as part of its Bid, a Bid Security denominated in the currency and in the amount as specified in BDS. The Bid Security shall be submitted at the Bidder's option in the form of banker's cheque/cash warrant/demand draft/cash order payable to the DGPC or in the form of bank guarantee from any of the Commercial Banks in Bhutan as per FORM No.1 of SECTION II.
- ITB.15.2. The Bid Security will remain valid till Thirty (30) days after the Bid validity as specified in the NIT
- ITB.15.3. The Bid Security shall be forfeited:
- ITB. 15.3.1. If a Bidder withdraws its Bid during the period of Bid validity as per **ITB.13.1.**
- ITB. 15.3.2. If a Bidder does not accept the arithmetical corrections of its Bid price, as per **ITB.12.1.**
- ITB. 15.3.3. If the Bidder fails to accept the letter of award or fails to sign the Contract in accordance with **ITB.24.**
- ITB.15.4. Immediately after the award of contract the Bid Security of all the unsuccessful Bidders, shall be returned within fifteen (15) working days of the award of contract. In case of single stage-two envelope mode of tendering, Bid Security of non-responsive Bids shall be returned immediately after technical evaluation.
- ITB.15.5. The Bid Security of the successful Bidder shall be returned immediately after the signing of Contract by the successful Bidder to whom the contract is awarded.

ITB.16. Documents Comprising the Bids

- ITB.16.1. The Bid to be prepared and submitted by the Bidder shall consist of the following documents
- The Bid Form as per Form No.3 of Section II- Bidding Forms;
 - Certificate of Incorporation, Tax Clearance Certificate and Certificate by CDB;
 - Original Demand Draft/ Bank Guarantee for the amount of Bid Security as specified in NIT;
 - Priced Bill of Quantities as per Form No 6. of Section II- Bidding Forms;
 - Deviation Schedule as per Form-2A and Form 2B of the Section II- Bidding Forms;
 - Power of Attorney, as per Form: 4 of Section II- Bidding Forms, if required;
 - Performance Evaluation System Acceptance Form, as per Form: 7 of Section II- Bidding Forms;
 - Any other **additional information/** document which the Bidder wishes to provide in his Bid.
- ITB.16.2. In addition to the requirements stipulated above, the Bidder should also meet the qualifying requirements stipulated in BDS.



ITB.17. Signing of Bids

ITB.17.1. The Bidder shall prepare one (1) original and copies (number as specified in BDS) of the complete set of documents constituting the Bid as described in **ITB.16.1**, and clearly mark each as "Original Bid" and 'Copy No: 1', 'Copy No: 2', etc. In the event of any discrepancy between the copies and original Bid, the original shall prevail. The BDS, GCC, SCC, Technical Specifications and Drawings including any clarifications and/ or amendments thereto, duly sealed and signed by an authorized signatory of the Bidder as a condition of acceptance. The original and all copies of the Bid shall be typed or written in indelible ink and shall be signed by a person (s) duly authorized by the Bidder with official seal. However, any published document submitted along with the Bid shall be signed by the authorized signatory(ies) at least on the first page and last page of such document. Any interlineations, erasures, or overwriting shall be valid only if they are signed or initialled by the person(s) signing the Bid.

ITB.18. Submission of Bids

ITB.18.1. Each Bidder shall be permitted to submit only one Bid against any NIT. In case, a Bidder and its Affiliate have submitted separate Bids, against the same NIT, all such Bids shall be rejected.

ITB.18.2. Bids shall be delivered by hand, courier or registered post so as to reach DGPC at the address specified in BDS on or before the date and time mentioned in BDS Bid sent by Fax/ or on Email will not be accepted.

ITB.18.3. Bids are to be submitted in a single closed Cover Envelope containing Envelope I and Envelope II(in case of Single Stage Single Envelope) or Envelope I, Envelope II and Envelop III (in case of Single Stage Two Envelope) with superscription [*Insert Subscription*] on envelope as specified in the BDS

ITB.18.4. All envelopes shall be sealed with adhesive or other sealant to prevent reopening and be signed across their seals by the person authorized to sign the Bid on behalf of the Bidder.

ITB.19. Opening of Bid

ITB.19.1. In the case of Single Stage Two Envelope Bids, on the deadline for submission of Bid the Technical Bid shall only be opened. The date for opening of the Price Bid shall be intimated at the appropriate time to the Bidders whose Bid is found responsive in the techno-commercial evaluation. In the case of Single Stage Single Envelope Bids, the technical and financial Bid shall be opened on the same date and time so specified in the presence of representatives of the Bidder who wishes to attend. During the Price Bid opening the following information shall be publicly announced for the Bidders to note:

- a. The name of the Bidder;
- b. The total price offered;
- c. Discounts offered;
- d. Such other details as DGPC may consider appropriate



- ITB.19.2. The DGPC will open the Bids, in the presence of Bidder's representatives who choose to attend at the date, time and place mentioned in the invitation for Bid. However, the Bidder's representative must produce an authorization letter from the Bidder at the time of opening of tenders. Unless this letter is presented, the representative will not be allowed to attend the opening of tenders. Only one representative against each Bid will be allowed to attend.
- ITB.19.3. Bid (if any) for which an acceptable notice of withdrawal has been received pursuant to **ITB.10.1** shall not be opened. On opening the remaining Bids the DGPC will examine them to determine whether the same are complete, requisite Bid Securities have been furnished, documents have been properly signed and the Bids are generally in order.
- ITB.19.4. At Bid opening, DGPC will announce the Bidders' names, written notifications of Bid modifications or withdrawal, if any, furnishing of requisite Bid Security and such other details as the DGPC may consider appropriate.
- ITB.19.5. DGPC shall prepare, for its own records, minutes of Bid opening and obtain the signature of the bidders attending the bid opening.
- ITB.19.6. Normally no request for extension of Bid Opening Date will be entertained. However, in case of any changes in the specifications, inadequate response or for any other reasons, DGPC may at its discretion, extend the Bid opening date and/or time.

ITB.20. Bid Evaluation

- ITB.20.1. After the opening of Bids, information relating to the examination, clarification, and evaluation of Bids and recommendations for award shall not be disclosed to Bidders or other persons not officially concerned with the evaluation process until after the award of the Contract is announced.
- ITB.20.2. To facilitate examination, evaluation and comparison of Bids the DGPC may, at its discretion, ask the Bidder for clarifications of its Bid. The request for clarification and the response shall be in writing and no change in the price or substance of the Bid shall be sought, offered or permitted.
- ITB.20.3. Prior to detailed evaluation, the DGPC will determine the substantial responsiveness of each Bid to the Bidding Document. For this purpose, a substantially responsive Bid is one which conforms to all the terms and conditions of the Bidding Document without material deviations. The DGPC's determination of Bid's responsiveness is to be based on the contents of the Bid itself without recourse to extrinsic evidence.
- ITB.20.4. A Bid determined as not substantially responsive to the Bidding Documents will be rejected by the DGPC and may not subsequently be made responsive by the Bidder by correction of the non-conformity.
- ITB.20.5. The DGPC may waive minor infirmity or nonconformity or irregularity on a Bid that does not constitute a material deviation, provided such waiver does not prejudice or affect the relative ranking of any Bidder.



- ITB.20.6. The evaluation shall be done on the basis of total price for all the items included in the Bill of Quantities
- ITB.20.7. If the Bid price of the lowest evaluated Bid appears abnormally low and/or seriously unbalanced, DGPC may require the Bidder to produce written explanations of justifications and detailed price analysis for any or all items of the Bill of Quantities to demonstrate the internal consistency of those prices with the construction methods and schedule proposed. Abnormally low Bid may or may not be accepted. If DGPC decides to accept the abnormally low Bid /or the bid with serious unbalanced rates after considering the above, the Bidder shall be required to provide differential security equivalent to the difference between the estimated and quoted price to a maximum of (ten percent) 10% of the quoted price, to protect DGPC against any financial loss in the event of default of the successful Bidder under the Contract. The differential security is to be valid till thirty (30) days beyond completion period. If the prices of all the received bids are abnormally high in the discretion of the DGPC, then the DGPC may seek justification from the bidder for the high rates and if necessary negotiate with the lowest evaluated bidder and may reject the bid if considered to be abnormally higher than the estimated cost.
- ITB.20.8. DGPC may grant a margin of preference to Domestic Bidders. The procedure used to apply the margin of preference shall be as stipulated in the BDS.

ITB.21. Contacting the DGPC

- ITB.21.1. No Bidder shall contact the DGPC on any matter relating to its Bid, from the time of the Bid opening to the time the Contract is awarded
- ITB.21.2. An effort by a Bidder to influence the DGPC in its Bid evaluation, Bid comparison or Contract award decisions may result in rejection of their Bid.

ITB.22. Award Criteria

- ITB.22.1. DGPC will award the Contract to the successful bidder whose bid has been determined to be substantially responsive and has been determined as the lowest evaluated bid.

ITB.23. Deviations:

- ITB.23.1. Bidders shall not be permitted to take any deviation from the terms and conditions as specified in the Bidding Documents. However, should the Bidders still envisage any exceptions/deviations to the terms and conditions of the Bid Document the same should be indicated in the deviation schedule as per Bidding Form No. 2 along with the technical Bid. If the proforma is left blank or not submitted, then it will be construed that the Bidder has not taken any exception/deviation to the terms and conditions of the Bid Document. Bidders may note that deviations, variations and additional conditions etc. found elsewhere in the Bid other than those stated in the Deviation Schedules, save those pertaining to any rebates, shall not be given effect to in evaluation and it will be assumed that the Bidder complies to all the conditions of Bidding Documents. In case Bidder refuses to withdraw, without any cost to the DGPC, those deviations which the Bidder did not state in the Deviation Schedules, the Bid Security of the Bidder may be forfeited.



ITB.23.2. Deviations specifically declared by the Bidders in the respective Deviation Schedule only will be taken into account for the purpose of evaluation. The Bidders are required to declare the additional prices for the withdrawal of the deviations declared by them in the Bidding Form No. 2B. Such prices declared by the Bidders for the withdrawal of the deviations in the Deviation Schedule shall be added to the Bid price to compensate for those deviations. In case prices for the withdrawal of deviations are not furnished by the Bidder, the DGPC shall convert such deviations into BTN value and add to the Bid price to compensate for these deviations. In determining the value of the Deviations, the DGPC will use parameters consistent with those specified in the specifications and documents and/or other information as necessary and available to the DGPC. In case the Bidder refuses to withdraw the deviations at the cost of withdrawal indicated by the Bidder in the Deviation Schedule, the Bid Security of the Bidder may be forfeited.

ITB.23.3. DGPC reserves the right to accept any Bid and to reject any or all Bids and to annul the Bidding process and reject all Bids at any time prior to Contract award, without thereby incurring any liability to Bidders or any obligation to inform the affected Bidders on the grounds for such action of the DGPC

ITB.24. Notification of Award:

ITB.24.1. Prior to expiry of the period of Bid validity, DGPC will notify the successful Bidder, by a Letter of Award (LoA) as per Form 2 of Section V (two copies), in writing, that its Bid has been accepted indicating the award price. The successful bidder shall return one copy of the Letter of Award to DGPC after duly recording “Accepted Unconditionally” under the signature of the authorised signatory within 15 days from the date of Letter of Award.

ITB.24.2. The notification of award will constitute the formation of the Contract until the formal Contract Agreement is executed. After acceptance of the DGPC shall send two copies of the Contract Agreement duly signed by the authorised representative of the DGPC for signature by the Contractor.

ITB.24.3. The Contractor shall return a duplicate copy of the Contract Agreement and the other enclosed documents duly signed and stamped, as a token of unconditional acceptance of the Contract Agreement, within a week from the date of issue of Contract Agreement and retain one copy for his record and reference.

ITB.25. Debriefing by DGPC

ITB.25.1. On receipt of DGPC’s Notification of Award referred to in ITB.24, an unsuccessful bidder has three (3) working days to make a written request to DGPC for a debriefing. DGPC shall provide a debriefing to all unsuccessful bidders whose request has been received within this deadline.

ITB.25.2. Where a request for debriefing has been received within the deadline, DGPC shall provide a debriefing within five (5) working days.

ITB.25.3. DGPC shall discuss only such bids and not the bids of other competitors. The debriefing shall not include:

(a) point-by-point comparisons with another Bid; and



(b) information that is confidential or commercially sensitive to other Bidders.

ITB.25.4. The Purpose of debriefing is to inform the aggrieved bidder of the reasons for lack of success, pointing out the specific shortcomings in its bid without disclosing contents of other bids

ITB.26. Retention Money

ITB.26.1. The DGPC shall retain ten percent (10%) of the value of each running bill due to a Contractor till the end of the Defect Liability Period. The retention money is the aggregate monies retained by the DGPC from the amount payable to the Contractor to the extent that the final retained amount reaches the limit of retention money as per the contract agreement which shall be ten percent (10%) of the Contract Price.

ITB.26.2. The retention money or part thereof may be returned to the Contractor on completion of the Defect Liability Period. After completion of the work, the retention money may be returned to the contractor against his submission of a bank guarantee, acceptable to the Procuring agency. Such bank guarantee shall be valid until the issue of a No Defect Liability Certificate.

ITB.26.3. If the Contractor fails to remedy any reported defect within the Defect Liability Period, the DGPC shall withhold the payment or realize claims from the Retention Money, of an amount, which in the opinion of the DGPC, represents the cost of the defects to be remedied.

ITB.27. Performance Evaluation of Contractor

ITB.27.1. A contractor performance evaluation is a standardized, systematic and objective assessment of a contractor's performance on a specific project contract.

ITB.27.2. The performance evaluation criteria shall be used by each Project Manager/Site Engineer immediately with the commencement of any work or services after the award of contract. The contractors shall be evaluated as the work progresses.

ITB.27.3. The Performance Evaluation System for Contractors is described at SECTION VIII of this Bidding Document.

ITB.27.4. The Contractor is required to sign and submit Form 14: Performance Evaluation System Acceptance along with their bid.



SECTION II- BID DATA SHEET



SECTION II- BID DATA SHEET

ITB Clause Reference	Amendments of, and Supplements to, Clauses in the Instruction to Bidders
ITB.6.1	<p>Tshewang Namgyel Head, Technical Support Unit Kurichhu Hydropower Plant Druk Green Power Corporation Limited Post Box No.: 43002 Gyalpoizhing, Mongar, Bhutan Email: t.namgyel837@drukgreen.bt Telephone: +975 4 744145</p> <p>Date & Time up to which clarification requests will be received: Date: April 04, 2024</p>
ITB.13.1	The Bid should be valid for a period of 60 days from the date of Bid Opening
ITB.14.1	<p>The foreign currencies of the Bid to be quoted shall be any one of the following: <i>[Not applicable]</i></p>
ITB.15.1	<p>The amount and currency of the Bid Security shall be Nu. 38,000.00</p> <p>Bidder has the option of depositing the bid security directly to the Kurichhu Hydropower Plant, Druk Green Power Corporation, Gyalpoizhing account maintained in the Bank of Bhutan, Account No. 101827797. The bidder shall submit the deposit slip with the bid.</p>
ITB.16.2	<p>The following Qualifying Requirement has to be met by the Bidder</p> <p>Technical</p> <p>i) The skilled and experienced manpower required for the timely and quality execution of the work to be made available for the Contract by the Bidder shall be:</p> <p>1. Site Supervisor - 1 No</p> <p>The Bidder should submit the CV for the declared manpower and Education certificate of Site Supervisor to authenticate the qualification and experience.</p> <p>ii) The Firms are advised to visit and examine the Site and its technical specifications where the work to be carried out and obtain for itself on its own responsibility and risk, all information that may be necessary for preparing the bid. The cost of visiting the site shall be borne by the firm fully. KHP shall facilitate the site visit and the supplier is required to furnish advance intimation of his/her Site visit.</p>



ITB.18.2	<p>Bids to be addressed to and submitted to:</p> <p>Chief Engineer Kurichhu Hydropower Plant Druk Green Power Corporation Limited Post-Box No.: 43002 Gyalpoizhing, Mongar, Bhutan Email: z.zangpo1598@drukgreen.bt Telephone: +975 4 744111</p> <p>Date & Time (Bhutan Time) up to which Bids will be received: Date: April 5, 2024 Time: 14:30 Hrs.</p>
ITB.17.1	<p>In addition to the original of the Bid, the number of copies of the Bid required shall be: [one].</p>
ITB.18.3	<p>For Single Stage Single Envelope</p> <p>Superscript of Cover Envelope:</p> <p>“CONFIDENTIAL”</p> <p>Bid for Construction of Boat Shed and External Wall Repainting of Power House bearing: KHP0003/2024 dated 21/03/2024.</p> <p>Name and address of Bidder : Not to be Opened Before Due Date for Opening on April 05,2024, at 15:00 Hrs</p> <p>Chief Engineer Kurichhu Hydropower Plant Druk Green Power Corporation Limited Post Box No.: 43002 Gyalpoizhing, Mongar, Bhutan Phone: +975-4-744111</p> <p>Superscript of Envelope 1: “Bid Security for Bid Construction of Boat Shed and External Wall Repainting of Power House bearing: KHP0003/2024 dated 21/03/2024.</p> <p>Name of Bidder:.....</p> <p>Superscript of Envelope 2:</p> <p>Bid for Construction of Boat Shed and External Wall Repainting of Power House bearing: KHP0003/2024 dated 21/03/2024.</p>



	Name of Bidder: Not to be Opened Before Due Date for Opening on April 05,2024, at 15:00hrs
ITB.20.8	The margin of domestic preference of five percent (10%) [“shall not”] apply.



SECTION III- BIDDING FORMS



SECTION III- BIDDING FORMS

Form 1: Bid Security (Bank Guarantee)

(On non-judicial stamp paper of the value relevant to the place of execution)

[The **Bank/Bidder** shall fill in this Bank Guarantee form in accordance with the instructions indicated in brackets.]

[Bank's Name, and Address of Issuing Branch or Office]

Beneficiary: _____ [Name and Address of Employer]

Date: _____

BID GUARANTEE No.: _____

We have been informed that [name of the Bidder] (hereinafter called "the Bidder") has submitted to you its Bid dated (hereinafter called "the Bid") for the execution of [name of contract] under Invitation for Bids No. [IFB number] ("the IFB").

Furthermore, we understand that, according to your conditions, Bids must be supported by a Bid Guarantee.

At the request of the Bidder, we [name of Bank] hereby irrevocably undertake to pay you any sum or sums not exceeding in total an amount of [amount in figures] ([amount in words]) upon receipt by us of your first demand in writing accompanied by a written statement stating that the Bidder is in breach of its obligation(s) under the bid conditions, because the Bidder:

- (a) has withdrawn its Bid during the period of Bid validity specified by the Bidder in the Form of Bid; or
- (b) having been notified of the acceptance of its Bid by the Employer during the period of Bid validity, (i) fails or refuses to execute the Contract Form, if required.

This guarantee will expire: (a) if the Bidder is the successful Bidder, upon our receipt of copies of the Contract signed by the Bidder; or (b) if the Bidder is not the successful Bidder, upon the earlier of (i) our receipt of a copy of your notification to the Bidder of the name of the successful Bidder; or (ii) 30 days after the expiration of the Bidder's Bid.

Consequently, any demand for payment under this guarantee must be received by us at this office on or before that date.

[signature(s)]



Form 2A: Deviation Schedule of Technical Bid
(Only exceptions/deviations to be mentioned)

NIT No.: **KHP0003/2024**
Bidder's Name & Address:
.....

To
[DGPC's Name and Address]

The following are the deviations and variations from and exceptions to the terms, conditions and specifications of the Bidding Documents for the construction of.....*[insert brief description of package]*..... These deviations and variations are exhaustive. We shall withdraw the deviations proposed by us in this Form at the cost of withdrawal indicated in the financial bid, failing which our Bid may be rejected and bid security forfeited.

We confirm that except for the deviations and variations stated in this Form to our Bid, the entire work shall be performed as per specifications and conditions of the Bidding Documents without any extra cost to DGPC, irrespective of any mention to the contrary anywhere else in the Bid, failing which our Bid may be rejected and Bid security forfeited.

Further, we agree that additional condition, deviation, if any, found in the Bidding Documents other than those stated in this Form, save those pertaining to any rebates offered, shall not be given effect to.

Section / Clause No	Page No.	Statement of Deviations

Sealed and Signed:



Form 2B: Deviation Schedule of Financial Bid

(The deviation mentioned in the schedule shall be the same deviation as mentioned in Form 2A and submitted along with the technical bid. Additionally, only the cost of withdrawal, if any, shall be mentioned against each deviation)

NIT No.: **KHP0003/2024**
Bidder's Name & Address:
.....

To
Chief Engineer,
Plant Head,
Kurichhu Hydropower Plant,
Druk Green Power Plant,
Gyalpoizhing, Mongar, Bhutan

The following are the deviations and variations from and exceptions to the terms, conditions and specifications of the Bidding Documents for construction of... ..[insert brief description of package]... .. These deviations and variations are exhaustive. We are furnishing below the cost of withdrawal for the deviations and variations stated in this Form. We shall withdraw the deviations proposed by us in this Form at the cost of withdrawal indicated herein, failing which our Bid may be rejected and bid security forfeited.

We confirm that except for the deviations and variations stated in this Form to our Bid, the entire work shall be performed as per specifications and conditions of the Bidding Documents without any extra cost to DGPC, irrespective of any mention to the contrary anywhere else in the Bid, failing which our Bid may be rejected and Bid security forfeited.

Further, we agree that additional condition, deviation, if any, found in the Bidding Documents other than those stated in this Form, save those pertaining to any rebates offered, shall not be given effect to.

Section / Clause No	Page No.	Statement of Deviations	Cost of withdrawal
---------------------	----------	-------------------------	--------------------

Sealed and Signed:



Form 3A: Technical Bid Submission Form

(The Bidder shall fill in and submit this bid form with the Bid. If Bidders do not fill in the Contract Price and do not sign this Bid form, the bids will be rejected.)

Name and Description of Works:
.....
.....

To
Chief Engineer,
Plant Head,
Kurichhu Hydropower Plant,
Druk Green Power Plant,
Gyalpoizhing, Mongar, Bhutan

NIT No.: **KHP0003/2024**

Dear Sir,

- 1) With reference to your invitation for Bids, I/We have examined the bidding documents, including addenda(s) and clarifications (if any), the receipt of which is hereby acknowledged for the above-named Works and understood their contents.

I/We, hereby submit my/our offer to execute the Works described above in conformity with the General Conditions of Contract, Technical Specifications, Special Conditions of Contract and Addenda(s)/clarifications (if any) accompanying this Bid for the Contract Price as mentioned in the Price Bid.

- a. We are aware that the Bill of Quantities do not generally give a full description of the work to be performed under each item and we shall be deemed to have read the Technical Specifications and other bidding documents and Drawings to ascertain the full scope of work included in each item while filling-in the rates and prices. We agree that the entered rates and prices shall be deemed to include for the full scope as aforesaid, including overheads and profit.
 - b. We declare that as specified in the General Conditions of Contract, the rates of Bill of Quantities shall be subject to adjustment.
 - c. We understand that the arithmetical errors in the Bill of Quantities shall be corrected as per provisions of the ITB.
- 2) All information provided in my/our offer and attachments (in all the three envelopes, viz. Envelope I, Envelope II and Envelope III) thereof is true and correct and in line with the requirement of the bidding documents and all documents accompanying this offer are true copies of their respective originals.
 - 3) I/We confirm our prices are inclusive of all the applicable taxes, duties, levies, royalties and octroi for the performance of the Contract.



- 4) We hereby confirm that this Bid submission complies with the Bid Validity and Earnest Money Deposit required to be submitted in the form of for a sum of [Name of currency and amounts in figures and words]
- 5) I/We hereby declare that only the persons or firms interested in this proposal as principals are named here and that no other persons or company other than those mentioned herein have any interest in this Bid submission or in the Contract to be entered into and in good faith, without collusion or fraud, if the award is made on me/us.

I/We hereby also declare that any of the person or party (including my/our Subcontractor listed in the Bid) have not been declared ineligible to Bid for corrupt or fraudulent or collusive or coercive practice or banned from business dealings on any consideration by DGPC or any other government institutions/undertakings in Bhutan.

I/We also undertake that, in competing for (and, if the award is made to us, in executing) the above Contract, we will strictly observe the laws against fraud and corruption in force in Bhutan.

- 6) In line with the requirements of the bidding documents, we enclose herewith our Bid to execute the Works and remedy any defects therein, in conformity with such documents.
- 7) I/We undertake, if our bid is accepted, to commence the work from the date as may be stated in your Letter of Award to us, and to achieve completion of works within the time stated in the bidding documents.
- 8) We confirm that the ITB and GCC have been read carefully and understood the obligations of the Contractor fully and agree to comply with all the clauses which are mentioned therein. In case of any breach of any condition on our part, we shall be liable for actions as per terms and conditions of the Contract including rejection of bid and termination of Contract, if awarded.
- 9) I/We agree to abide by this Bid for a period of[insert Bid Validity]..... from the date fixed for submission of Bids as stipulated in the bidding documents, and it shall remain binding upon me/us and may be accepted by you at any time before the expiration of that period.
- 10) I/We understand that you are not bound to accept the lowest or any Bid you may receive.

We attach herewith the documents and information set to be furnished to you for evaluating our eligibility and Bid.

Sealed and Signed



Form 3B: Financial Bid Submission Form

(To be submitted on Bidder’s letterhead)

Name and Description of Works:

.....

.....

To
Chief Engineer,
Plant Head,
Kurichhu Hydropower Plant,
Druk Green Power Plant,
Gyalpoizhing, Mongar, Bhutan

NIT No.:.....

Dear Sir,

Having examined the Bidding Document, including addenda *[insert list]*, we offer to execute the *[name and identification number of Contract]* in accordance with the Conditions of Contract accompanying this Bid for the Contract Price of*[insert amount in numbers]*, *[insert amount in words]* *[insert name of currency]*.

This Bid and your written acceptance of it shall constitute a binding Contract between us. We understand that you are not bound to accept the lowest or any Bid you receive.

We hereby confirm that this Bid complies with the Bid validity and Bid Security required by the Bidding Document and specified in the Bidding Data Sheet.

In case if I withdraw my bid after opening for whatsoever reasons, *I agree to the forfeiture of the EMD/Bid Security.*

Sealed and Signed



Form 4: Power of Attorney

(To be executed on non-judicial stamp paper of appropriate value)

KNOW ALL MEN BY THESE PRESENTS THAT WE, [insert name of the Bidder]..... a Company incorporated under the[insert relevant statute of Bhutan]..... and having its registered office at[insert address]..... (hereinafter referred to as the “Bidder”) having been authorized by the Board of Directors of the Company, inter alia, to execute contracts in the name of and for and on behalf of the Company. I[insert name of the person giving the power of attorney]..... presently holding the position of [insert designation of the person giving the power of attorney]..... in the company do hereby constitute, appoint and authorize Mr..... [insert name, designation and residential address of the person to whom the power of attorney is being given]..... as our true and lawful attorney to do in our name and on our behalf all such acts, deeds, things necessary and incidental for submission of our Bid against NIT No., floated by Druk Green. I hereby further authorize the above attorney for signing and submission of the Bid and all other documents, information related to the Bid including undertakings, letters, certificates, declarations, clarifications, acceptances, guarantees, any amendments to the Bid and such documents related to the Bid, and providing responses and representing us in all the matters before Druk Green in connection with the Bid for the said NIT till the completion of the bidding process including signing of the contract.

I accordingly hereby nominate, constitute and appoint the above named severally, as my lawful attorney to do all or any of the acts specifically mentioned immediately herein above.

WE do hereby agree and undertake to ratify and confirm whatever the said Attorney shall lawfully do or cause to be done under and by virtue of this power of Attorney and the Acts of Attorney to all intents and purposes are done as if I had done the same on behalf of the Company if these presents had not been made.

IN WITNESS whereof I, have executed these presents this the day of at

EXECUTANT

Signature:.....
Name:.....
Designation:.....

ACCEPTED:

Signature of Attorney:.....
Name:.....
Designation:.....

Signature of the Attorney Attested



.....

EXECUTANT

Name.....

Designation.....

Office Seal.....

Note: The Power of Attorney should be notarized as per applicable legal provisions in the Kingdom of Bhutan



Form 5: Certificate Regarding Acceptance of Important Conditions

(To be kept in Envelope II)

To
Chief Engineer,
Plant Head,
Kurichhu Hydropower Plant,
Druk Green Power Plant,
Gyalpoizhing, Mongar, Bhutan

Dear Sir/Madam,
With reference to our Bid dated.....for.....[insert name of the Works].....against NIT No. KHP0003/2024, we hereby confirm that we have read the provisions of following clauses and further confirm that notwithstanding anything stated elsewhere to the contrary, the stipulations of these clauses are acceptable to us and we have not taken any deviation to any of these clauses anywhere in the Bid:

[List of clauses to be inserted as per BDS with clause reference no., and heading of the clause and document name]

- i.
- ii.
- iii.
- iv.
- v.
- vi.
- vii.
- viii.
- ix.

We further confirm that any deviation to the above clauses, found anywhere in our Bid, implicit or explicit, shall stand unconditionally withdrawn without any cost implication whatsoever to DGPC failing which the Bid security may be forfeited

Date :	Signature.....
Place :	Name.....
	Designation.....
	Seal.....

Note: The above certificate is to be submitted in the sealed envelope along with the Technical Bid (envelop II). In absence of this certificate the Bid shall be rejected and returned



Form 6: Bill of Quantities

SN	Description	Unit	Qty	Unit Rate (BTN)		Amount(Nu.)
				In figures	In words	
A	EXTERNAL WALL REPAINTING OF POWER HOUSE					
1	Dismantling steel work in built up sections without dismembering and stacking within 50 m lead (removing CI pipes)	M	216.00			
2	Demolishing cement concrete 1:3:6& richer, including disposal of materials within 50m lead	cu.m	41.00			
3	Providing and laying in position plain cement concrete excluding the cost of centering and shuttering - All work up to plinth level- 1:1.5:3 (1 cement: 1.5 sand: 3 graded crushed rock 20 mm nominal size)	cu.m	25.20			
4	Providing & fixing centering and shuttering (formwork), including strutting, propping etc. and removal of formwork	sq.m	25.20			
5	Providing & laying cement plaster, finished with floating coat of neat cement-12mm plaster in C.M 1:3	sq.m	100.80			



6	Surface preparation removing by scraping, sand papering, including scratch repairs-washable distemper	sq.m	4,767.19			
7	Providing & applying one coat of primers before emulsion paint is applied	sq.m	4,767.19			
8	Providing and applying finishing coats- Acrylic emulsion two or more coats as per requirement at site	sq.m	4,767.19			
9	Vinyl plastic emulsion paint, for cement, masonry, plaster, two coats on new work	sq.m	240.00			
10	Synthetic enamel, for steel & wood work/one coat on old work	sq.m	100.00			
11	Providing, preparing and applying Sumdang washable painting	sq.m	191.00			
B	CONSTRUCTION OF BOAT SHED					
	CLEARING & GRUBBING					
1	Clearing jungle including uprooting of vegetation & trees of girth <300mm & disposal within 50m of the site	sq.m	52.50			
	DEMOLISHING WORK					



2	Demolishing cement concrete 1:3:6& richer, including disposal of materials within 50m lead	cu.m	6.43			
	EARTH WORKS					
3	Earthwork in surface excavation, depth<300mm, width>1.5m, area>10 Sq.m in plan, including disposal of excavated earth within 50m lead & 1.5m lift and disposed soil to be neatly dressed - All types of rock with or without blasting	Cu.m	154.56			
4	Filling of trenches, sides of foundations etc. in layers <200mm using selected excavated earth, ramming etc. within lead 50 m & lift 1.5m	Cu.m	2.79			
	STONE WORK					
5	Providing and laying Hand packed stone filling or soling with stones	cu.m	10.38			
6	Providing & laying Random Rubble Masonry with hard stone in foundation & plinth-in cement motor 1:4	cu.m	9.98			
	CONCRETE WORKS					
7	Providing and laying in position plain cement concrete excluding the cost of centering and shuttering - All work upto plinth level- 1:2:4 (1	Cu.m	6.94			



	cement : 2 sand : 4 graded crushed rock 20 mm nominal size)					
8	Providing and laying in position plain cement concrete excluding the cost of centering and shuttering - All work upto plinth level- 1:1:2(1 cement : 1 sand : 2 graded crushed rock 20 mm nominal size)	Cu.m	4.25			
9	Providing & fixing centering and shuttering (formwork), including strutting, propping etc. and removal of formwork-Foundation and plinth etc.	sq.m	34.95			
	BRICK WORK					
10	Providing & laying second class brick masonry(250mm) in foundation/plinth & super structure CM 1:4	Cu.m	7.80			
	REINFORCEMENT CONCRETE					
11	Providing & laying in position reinforced cement concrete work in plinth and skirting courses, fillers, columns, pillars, posts and struts upto floor five level excluding the cost of centering, shuttering and reinforcement- all levels 1:1.5:3 (1 cement : 1.5 sand : 3 graded crushed rock 20 mm nominal size)	Cu.m	3.42			



12	Providing & fixing Thermo-Mechanically Treated reinforcement bar (Yield Strength 500 Mpa) for RCC work including cutting, bending, binding and placing in position complete.	Kg	478.01			
	ROOFING & EVE BOARD					
13	Providing & fixing Pre-Painted Galvalume (PPGL) sheeting, including necessary accessories for fixing sheet (excluding the cost of purlins, rafter and trusses) – 25g	sq.m	111.26			
14	Providing & fixing 600 mm ridges or hips in Pre-Painted Galvalume (PPGL) sheets, including necessary accessories for fixing sheet	M	16.48			
	PAINTING WORK					
15	Providing & applying one coat of pink primer of approved colour and texture by the client on the eve board and pelmets	sq.m	4.28			
16	Providing & applying two coats of Acrylic washable distemper including cement primer	sq.m	68.56			



17	Providing & applying two coats of synthetic enamel paint of approved colour and texture by the client.	sq.m	101.05			
	STEEL WORK					
18	Steel work welded, in built up sections, trusses, frame-works including cutting, hoisting, fixing and appl. priming coat of red- in channels	Kg	1,616.86			
19	Providing & fixing MS round hold-down bolts with nuts and washer plates-16mm dia	Kg	6.38			
20	Providing, making and fixing MS straps, flats, sole plates etc.-8mm thick	Kg	47.64			
	PLASTERING WORKS					
21	Providing & laying 15mm cement plaster at the exterior brick wall - C.M 1:4 (External Wall)	Sq.m	32.50			
22	Providing & laying 12mm cement plaster at the interior brick wall - C.M 1:4 (Internal Wall)	Sq.m	27.50			
	CEILING WORKS					



23	Providing and fabrication of suspended ceiling frame work in MS flats/tees 30x4mm fabricated with MS angles 30x30x4mm along the perimeter of ceiling with screws fixed to brick wall/partition/RCC members at 1000mm c/c. Bison board (8mm thick) with one coat of acrylic distemper fixed with screw to ceiling section and the boards are to be jointed and finished as per the satisfaction of site-incharge (including the cost of Bison board)	Sq.m	19.50			
24	Providing & fixing Eaves board (225x25mm) with moulding fitted and fixed with necessary screws - Mixed Conifer	M	19.00			
	DOORS/WINDOWS & ACCESSORIES					
	Providing & fixing anodised Aluminium section for doors, windows, ventilators, partitions frames, false ceiling framing of specified sections including all accessories such as U-rubber gasket for fixing glass panes, weather strips or weather deals. roller. springs. etc complete (excluding the cost of glass panes or boards in case of partitions/doors/windows and ceiling boards in case of ceiling)- Sliding.					



	openable and pivoted windows/sliding and openable doors, complete as per the drawings.					
25	Sliding window	Kg	3.50			
26	Open able doors	Kg	54.80			
27	Extra for providing and fixing plain glass panes on aluminum section complete (excluding the cost of aluminum frame & accessories) 5.5mm thick, plain glass	sq.m	1.38			
28	Extra for providing and fixing aluminum plastic composite panel (excluding the cost of aluminum frame & accessories) 5.5mm thick.	sq.m	5.38			
29	Providing & fixing brass handle with necessary screws etc. complete-150mm	Each	1.00			
30	Providing & fixing brass tower bolt (barrel type) with necessary screws etc. complete-150mm	Each	2.00			
31	Providing & fixing brass sliding door bolt, bright finished, enamelled with necessary screws etc. complete-300mm	Each	1.00			



	PLINTH PROTECTION & SIDE DRAIN					
32	Providing & laying 50mm thick Plinth Protection and grouted with fine sand mix including well rammed finishing the top smooth with cement concrete 1:3:6, 20mm aggregate laid over 75mm thick layer of compacted gravel (40mm)	Sq.m	12.00			
33	Constructing 150mm x 200mm depth second class brick masonry open surface drain in cement mortar 1:4 including earth work in excavation 100mm thick concrete bed 1:5:10, 40mm aggregate and 25mm thick cement concrete 1:2:4, 12mm aggregate for filling haunches 12mm cement plastering 1:4 with a floating coat of neat cement and disposal of surplus earth etc, complete	M	40.00			
	ELECTRICAL WORK					
34	Wiring for points in excess length above long points with 1.1kV grade, PVC insulated copper conductor cable in surface MS conduit including connections, painting, testing & commissioning etc. as required -2x4 sq.mm	M	45.00			



35	Installation, testing and commissioning of prewired LED fittings of all surface type complete with all accessories and tubes directly on ceiling/wall as required including connection with PVC insulated copper conductor - 1 sq.mm single core cable 1.1 KV grade	M	90.00			
36	Supplying & fixing of switch/socket on existing PVC /metal/ moulded tough surface box, metal box (recessed or surface)/ junction box (PVC/metal) including necessary cutting, connection testing etc. as required. - 5/6 pin, 6/16A socket outlet, shuttered	Each	2.00			
37	Supplying and installation of prewired indoor LED lamp/tubes luminaries - LED lamp/tubes 60W with complete weather proof fittings	Set	1.00			
38	Supplying and installation of ceiling fan 240-volt A.C 1400 rpm with all accessories such as down rod, sweep 3 Nos., canopy 2 Nos., condenser and fan body etc. complete as required - 1200 mm sweep	Each	1.00			
	Supplying & fixing of 6A one-way modular switch along with the metal box to be fixed in					



	the wall (recessed) with fiber sheet cover including necessary cutting, connection testing etc. as required.					
39	1 Module box with 1 way switch	NO	1.00			
40	3 Module box with 1 way switch	NO	1.00			
41	Supplying & fixing of switch and socket combined along with the metal box to be fixed in the wall (recessed) with fiber sheet cover including necessary cutting, connection testing etc. as required. - 5/6 pin, 16A switch and socket combined, shuttered	Each	1.00			
TOTAL AMOUNT(Nu.)						

Total Price in figures (Nu.)

Total Price in words.....



Form 7: Performance Evaluation System Acceptance

To
Chief Engineer,
Plant Head,
Kurichhu Hydropower Plant,
Druk Green Power Plant,
Gyalpoizhing, Mongar, Bhutan

Dear Sir/Madam,

With reference to our Bid dated.....for.....[insert name of work].....against NIT No.KHP0003/2024, we hereby confirm that we have read the provisions in Section VIII regarding the performance evaluation system and we hereby agree to abide by the provisions in the chapter on performance evaluation or do affirm as follows:

1. We agree to abide by all the provisions on the performance evaluation of works.
2. If our bid is accepted, we agree to be assessed as per the performance evaluation rating methodology adopted by DGPC.
3. We accept the rating depending on our performance and any action thereof.
4. We shall be liable for any breach of this undertaking and non-compliance to the provisions of the performance evaluation system.

Sealed and signed	



SECTION IV- GENERAL CONDITIONS OF CONTRACT



SECTION IV- GENERAL CONDITIONS OF CONTRACT

GCC.1. Definition

GCC.1.1. The following terms and expressions used herein shall have the meaning as indicated therein:

- a. “Bid” means an offer to execute the Works submitted by the Bidder to DGPC in accordance with the terms and conditions set out in the Bidding Documents inviting such offers. The term “Tender” is synonymous with the term “Bid”;
- b. “Bidder” means an eligible legal entity who has been invited to submit the Bid and have submitted the Bid in response to such invitation;
- c. “Bidding Documents” means the set of documents up-loaded by DGPC on its website for downloading by potential Bidders in which the specifications, terms and conditions of the proposed Work are prescribed. The terms “Bidding Documents”, “Tender Documents” and “Bid Documents” are synonymous;
- d. “Bill of Quantities” means the completed Bill of Quantities forming part of Bid which indicates the total quoted price;
- e. “Contract Price” means the aggregate price payable to the Contractor as specified in the Contract at the time of award, subject to such additions and adjustments thereto or deductions therefrom as may be made pursuant to the provisions of the Contract till the completion of the contract, the price so adjusted shall be termed as Executed Price;
- f. “Contractor” means the Bidder whose Bid to perform the Contract has been accepted by DGPC and is named as such in the Contract Agreement, and includes the legal successors or permitted assigns of the Contractor;
- g. “Defect Liability Period” means the period of validity of the warranties given by the Contractor commencing at completion of the Works or a part thereof, if separate completion of the Works for such part has been provided in the Contract, during which the Contractor is responsible for defects with respect to the Work;
- h. “Engineer” is the person who is responsible for supervising the execution of the works and administering the Contract;
- i. “Site” means the land and other places upon which the Facilities are to be installed, and such other land or places as may be specified in the Contract as forming part of the Site.

GCC.2. Language

GCC.2.1. The Contract, as well as all correspondence and documents relating to the Contract exchanged by the Contractor and DGPC, shall be written in English. Supporting documents and printed literature that are part of the Contract may be in another language provided they are accompanied by an accurate translation of the relevant



passages in English, in which case, for purposes of interpretation of the Contract, the translation shall govern.

GCC.2.2. The Contractor shall bear all costs of translation to the governing language and all risks of the accuracy of such translation, for documents provided by the Contractor.

GCC.3. Governing Law

GCC.3.1. The Contract shall be governed by and interpreted in accordance with the laws of the Kingdom of Bhutan and courts at Thimphu shall have exclusive jurisdiction for settlement of disputes, if any, between DGPC and Contractor unless otherwise stated.

GCC.4. Compliance with Law

GCC.4.1. The Contractor shall, in all matters arising in the performance of the Contract, comply in all respects, give all notices and pay all fees required by the provisions of any statute, ordinance or other law or any regulation or by-law of any duly constituted authority of the Kingdom of Bhutan.

GCC.4.2. The Contractor shall indemnify and hold harmless DGPC from and against any and all liabilities, damages, claims, fines, penalties and expenses of whatever nature arising or resulting from the violation of such laws by the Contractor or its personnel.

GCC.5. Fraud and Corruption

GCC.5.1. If DGPC determines that the Contractor and/or any of its personnel, or its agents, or its Subcontractors, and/or their employees has engaged in corrupt, fraudulent, collusive coercive, or obstructive practices, in competing for or in executing the Contract, then Druk Green may, after giving fourteen (14) days' notice to the Contractor, terminate the Contract and expel him from the Site.

GCC.5.2. For the purpose of the above sub-clause:

- a. "Corrupt practice" is the offering, giving, receiving or soliciting, directly or indirectly, of anything of value to influence improperly the actions of another party
- b. "Fraudulent practice" is any act or omission, including a misrepresentation, that knowingly or recklessly misleads, or attempts to mislead, a party to obtain a financial or other benefit or to avoid an obligation;
- c. "collusive practice" is an arrangement between two or more parties designed to achieve an improper purpose, including to influence improperly the actions of another party;
- d. "coercive practice" is impairing or harming, or threatening to impair or harm, directly or indirectly, any party or the property of the party to influence improperly the actions of a party;
- e. "obstructive practice" is
 - Deliberately, destroying, falsifying, altering or concealing of evidence material to the investigation or making false statements to



investigators in order to materially impede any investigation into allegations of a corrupt, fraudulent, coercive or collusive practice; and/or threatening, harassing or intimidating any party to prevent it from disclosing its knowledge of matters relevant to the investigation or from pursuing the investigation; or

- Acts intended materially to impede the exercise of the inspection rights of DGPC or any organization or person appointed by DGPC.

GCC.6. Contractor's Responsibilities

GCC.6.1. The Contractor shall construct the work in accordance with Section IV, Technical Specification, and the commencement and completion of Work requirement as per GCC.14 and GCC.15 and of General Conditions of Contract.

GCC.7. DGPC's Responsibilities

GCC.7.1. Whenever the construction of the work requires that the Contractor needs to obtain permits, approvals and/or import and other licenses or similar permissions from Bhutanese authorities, DGPC shall, if so required by the Contractor, use its best efforts to assist the Contractor in complying with such requirements in a timely and expeditious manner, but without incurring any costs and liabilities for any failure to obtain such permits, approval, and/or import and other licenses or similar permissions.

GCC.8. Welfare of Labour and Child Labour

GCC.8.1. The Contractor shall provide proper accommodation to his labourers and arrange proper water supply, conservancy and sanitation arrangements at the site in accordance with relevant regulations, rules and orders of the government.

The Contractor shall comply with the applicable minimum age, labour laws and requirements of (including applicable treaties which have been ratified by) the Government of Bhutan regarding hazardous forms of child labour.

GCC.9. Safety

GCC.9.1. The Contractor shall be responsible for the safety of all activities on the Site

GCC.9.2. The Contractor shall assume full responsibility and comply with all applicable safety regulations for the adequacy and safety of site operations and methods of construction and he shall adopt measures to prevent injuries to persons or damage to properties or utilities. He shall hold the Employer harmless from any liability for loss or damage resulting from his failures to take the necessary precautions. He shall avoid undue interference with private business, public travel, or with the work of other contractors. He shall take steps to protect the environment and to minimize noise, pollution or other undesirable effects resulting from his method of operation.

GCC.9.3. Non-compliance of the above clause will attract penalties as per the rules/regulations laid by Royal Government of Bhutan.



GCC.10. Quality Assurance Plan

GCC.10.1. Sampling, testing and quality assurance requirements shall be as per the details given in Technical Specifications. All costs associated with testing of materials required as per Technical Specifications shall be deemed to be included in the rates/prices in the Bill of Quantities.

GCC.11. Property

GCC.11.1. If the contract is terminated by the Employer because of the contractor's default, then, the contractor shall not be allowed to remove any materials on the Site, Plant, and Temporary Works until the matter is amicably resolved.

GCC.12. Insurance

GCC.12.1. The Contractor shall provide insurance as specified in SCC.

GCC.12.2. The Contractor shall deliver policies and certificates of insurance to the Engineer, for the Engineer's approval, before the Start Date.

GCC.12.3. If the Contractor does not provide any of the policies and certificates required, the DGPC may affect the insurance which the Contractor should have provided and recover the premiums the DGPC has paid from payments otherwise due to the Contractor or, if no payment is due, the payment of the premiums shall be a debt due.

GCC.13. Possession of the Site

GCC.13.1. DGPC shall give possession of the Site, or parts of the Site, to the Contractor on the date specified in the SCC.

GCC.14. Commencement of Work

GCC.14.1. The Contractor shall commence execution of the Works on the date specified in the SCC and shall carry out the Works in an expeditious manner.

GCC.14.2. If Contractor fails to commence the works within the above stated period, the DGPC may, at his sole discretion, terminate the Contract and forfeit the Bid Security, if any.

GCC.15. Completion of Work

GCC.15.1. The Contractor shall complete the Works from the date specified in the SCC.

GCC.16. Programme of Work

GCC.16.1. Within the time stated in the SCC, the Contractor shall submit to the Engineer for approval a work program. The Contractor shall submit to the Engineer for approval an updated Programme at intervals as stated in the SCC.

GCC.17. Compensation Events

GCC.17.1. The following shall be the Compensation Events:

- a. The DGPC does not give access to the Site or part of the Site by the Site Possession Date stated in the SCC; and



- b. If the payment is delayed pursuant to **GCC.17**.

GCC.18. Contract Price

- GCC.18.1. The Contract Price shall be as specified in the Contract subject to any additions and adjustments thereto or deductions therefrom as may be made pursuant to the Contract.
- GCC.18.2. The Contract Price shall be firm and not subject to any escalation till the completion of the Work as per the Contract or any amendment thereof

GCC.19. Payment Certificates

- GCC.19.1. The Contractor shall submit to the Engineer monthly statements of the estimated value of the work executed less the cumulative amount certified previously. The Engineer shall check the Contractor's monthly statement and certify the amount to be paid to the Contractor.
- GCC.19.2. The value of work executed shall be determined by the Engineer.
- GCC.19.3. The value of work executed shall comprise the value of the quantities of the items in the Schedule of Works completed.
- GCC.19.4. The value of work executed shall include the valuation of Variations, Certified Dayworks and Compensation Events.
- GCC.19.5. The Engineer may exclude any item certified in previous certificates or reduce the proportion of any item previously certified in any certificate in the light of later information

GCC.20. Terms of Payment

- GCC.20.1. The Contract Price shall be paid as per terms specified in SCC.
- GCC.20.2. Payments shall be made promptly by DGPC, no later than thirty (30) days after the receipt of invoices and documents, provided that the documents are compliant with all the requirements of DGPC. In case of incomplete/ non-compliant invoices and documents, DGPC shall ask the Contractor to re-submit the invoices and documents with full compliance.
- GCC.20.3. The currencies in which payments shall be made to the Contractor under this Contract shall be those in which the Contract Price is expressed.
- GCC.20.4. The release of first progressive running account bill payment shall be subject to submission of documentary evidence by the Contractor towards having taken the insurance policy (ies) in terms of relevant provisions of **GCC.12** and acceptance of the same by the Project Manager.

GCC.21. Taxes and Duties

- GCC.21.1. Except as otherwise specifically provided in the Contract, the Contractor shall bear and pay all taxes, duties, levies and charges assessed on the Contractor, its Subcontractors bylaws, regulations of the Kingdom of Bhutan in connection with the Works inside the Kingdom of Bhutan. The Contract Price shall be deemed to be inclusive of all such taxes, duties, levies, royalties, etc. on the materials incorporated into the Works.



GCC.21.2. Bidders participating from India, for bonafide use in the Kingdom of Bhutan shall quote the rates and prices for the items in the Bill of Quantities exclusive of any effect of the Integrated Goods and Service Tax (IGST). The IGST on the export of goods or services or both are covered under Zero Rated Supply as per Chapter VII, 16(1) THE INTEGRATED GOODS AND SERVICES TAX ACT, 2018 of India.

GCC.21.3. At the time of release of payment to the Contractor, tax shall be deducted at source (TDS) as per the relevant laws of Bhutan from the gross amount of bills. DGPC shall furnish necessary TDS Certificate to the Contractor, issued by the Department of Revenue & Customs, RGoB. The Contractor shall be responsible to deduct tax at source from the gross payments made to its Subcontractors and deposit the same to the account of RGoB as per provisions of relevant law in this regard in force from time to time.

GCC.21.4. If any tax exemptions, reductions, allowances or privileges may be available to the Contractor in the Kingdom of Bhutan, DGPC shall use its best efforts to enable the Contractor to benefit from any such tax savings to the maximum allowable extent.

GCC.22. Subcontracting

GCC.22.1. The Contractor may subcontract the Works/any part of the Works as specified in the SCC, with the prior written consent of the Project Manager. The qualifying requirements for the Subcontractors to perform the specified part of Works shall be specified in the SCC.

GCC.22.2. Where the Contractor is intending to subcontract any part of the Works, it shall propose a Subcontractor for any part of the Works out of the list furnished by the Contractor in his Bid. The Contractor along with his request for approval of Subcontractor shall also submit the requisite credentials of the Subcontractor proposed to be engaged, matching with the qualifying requirements prescribed in the SCC. The details so furnished by the Contractor shall be reviewed by the Project Manager. In case the Subcontractor proposed by the Contractor for the subcontracting is not considered acceptable, the Contractor will be required to furnish credentials of alternate Subcontractor for approval of the Project Manager. Based on the review and assessment, the Subcontractor shall be approved by the Project Manager within twenty-one (21) days of furnishing of credentials by the Contractor.

GCC.22.3. Any consent by the Project Manager for appointment of Subcontractor shall not relieve the Contractor from any liability or obligation under the Contract and he shall be responsible for the acts, defaults and neglects of any Subcontractor, his agents, servants or workmen as fully as if they were the acts, defaults or neglects of the Contractor, his agents, servants or workmen. Any work or part of the work other than those mentioned above shall not be subcontracted by the Contractor.

GCC.22.4. Notwithstanding the provisions of **GCC.22.2** above, the Contractor shall not be required to obtain prior approval of Project Manager for appointment of Subcontractor for:

- a. the provision of labour,



- b. the purchase of materials which are in accordance with the standards specified in the Contract, or
- c. the subcontracting of any part of the Works for which the Subcontractor is named in the Contract.

GCC.22.5. The Contractor shall not subcontract the whole of the Contract and shall also not subcontract any part of the scope of work which is specifically prohibited for subcontracting under the provisions of the Contract.

GCC.23. Retention Money

GCC.23.1. DGPC shall also retain 10% (ten percent) of the value of each running bill due to a Contractor till the end of the Defect Liability Period. The retention money is the aggregate monies retained by the DGPC from the amount payable to the Contractor to the extent that the final retained amount reaches the limit of retention money as per the contract agreement which shall be ten percent (10%) of the Contract Price.

GCC.23.2. The retention money or part thereof shall be returned to the Contractor on completion of the Defect Liability Period. After completion of the work, the retention money may be returned to the contractor against his submission of a bank guarantee, acceptable to the Procuring agency. Such bank guarantee shall be valid until the issue of a No Defect Liability Certificate.

GCC.23.3. If the Contractor fails to remedy any reported defect within the Defect Liability Period, the DGPC shall withhold the payment or realize claims from the Retention Money, of an amount, which in the opinion of the DGPC, represent the cost of the defects to be remedied

GCC.24. Liquidated Damages for delay

GCC.24.1. If the Contractor fails to complete the Work within the Completion Date specified in the Contract, DGPC may, without prejudice to all its other remedies under the Contract, deduct from the Contract Price, as liquidated damages, as specified in the SCC. This is an agreed genuine pre-estimate of the damages the DGPC may suffer due to delay in Completion of Work. If in the opinion of DGPC the Contractor is indefinitely delaying the construction, DGPC may terminate the Contract. In such event DGPC reserves the right to complete the Work from elsewhere at the sole risk and cost of the Contractor and recover all such extra costs if any incurred by DGPC in completing the Work from alternative sources.

GCC.25. Defect Liability

GCC.25.1. The Contractor shall ensure that the Work completed in accordance with the Contract Documents, is free from defects arising from any act or omission of the Contractor or arising from design, materials and workmanship, under normal use in the conditions prevailing in the Kingdom of Bhutan.

GCC.25.2. The Defect Liability Period shall be for twelve (12) months from the date the Work has been taken over by DGPC. Where any part of the Works is taken over separately, the Defects Liability Period for that part shall commence on the date it was taken over.



- GCC.25.3. DGPC shall give notice to the Contractor stating the nature of any such defects together with all available evidence thereof, promptly following the discovery thereof. DGPC shall provide all reasonable opportunities for the Contractor to inspect such defects.
- GCC.25.4. Upon receipt of such notice, the Contractor shall, within the period of fifteen (15) days shall complete the remedying of the defect.
- GCC.25.5. If, having been notified, the Contractor fails to remedy the defect within the period specified in GCC.25.4, DGPC may proceed to take within a reasonable period such remedial action as may be necessary, at the Contractor's risk and expense and without prejudice to any other rights which DGPC may have against the Contractor under the Contract.

GCC.26. Limitations of Liability

- GCC.26.1. Except in cases of gross negligence or willful misconduct:
- a. neither party shall be liable to the other party, whether in Contract, tort or otherwise, for any indirect or consequential loss or damage, loss of use, loss of production, or loss of profits or interest costs, provided that this exclusion shall not apply to any obligation of the Contractor to pay liquidated damages to DGPC; and
 - b. the aggregate liability of the Contractor to DGPC, whether under the Contract, in tort or otherwise, shall not exceed the total Contract Price, provided that this limitation shall not apply to the cost of repairing or replacing defective Works, or to any obligation of the Contractor to indemnify DGPC with respect to patent infringement

GCC.27. Force Majeure

- GCC.27.1. The Contractor shall not be liable for forfeiture of its Retention Money, liquidated damages or termination for default if and to the extent that it's delay in performance or other failure to perform its obligations under the Contract is the result of an event of Force Majeure.
- GCC.27.2. For the purposes of this Contract, "Force Majeure" means an exceptional event or circumstance:
- a. which is beyond a Party's control,
 - b. which such Party could not reasonably have provided against before entering into the Contract,
 - c. which, having arisen, such Party could not reasonably have avoided or overcome, and
 - d. which is not substantially attributable to the other Party.
- GCC.27.3. Force Majeure may include, but is not limited to, exceptional events or circumstances of the kind listed below, so long as conditions (a) to (d) above are satisfied:
- a. War, hostilities (whether war be declared or not), invasion, act of foreign enemies,



- b. Rebellion, terrorism, sabotage by persons other than the Contractor's Personnel, revolution, insurrection, military or usurped power, or civil war,
- c. Riot, commotion, disorder, strike or lockout by persons other than the Contractor's Personnel,
- d. Munitions of war, explosive materials, ionizing radiation or contamination by radio-activity, except as may be attributable to the Contractor's use of such munitions, explosives, radiation or radio-activity, and
- e. Natural catastrophes such as earthquake, hurricane, typhoon or volcanic activity.

GCC.27.4. However, force majeure shall not include the following:

- Rainfall
- Snowfall
- Strikes in other countries
- Non-availability of labourer and materials such as timbers, boulders, sand, and other materials
- Difficulty and risky terrain and remoteness of site.

GCC.27.5. If a Force Majeure situation arises, the Contractor shall promptly notify DGPC in writing of such condition and the cause thereof, along with documentary or pictorial evidence. Unless otherwise directed by DGPC in writing, the Contractor shall continue to perform its obligations under the Contract as far as is reasonably practical, and shall seek all reasonable alternative means for performance not prevented by the Force Majeure event.

GCC.28. Variation

GCC.28.1. Introducing a Change

GCC.28.1.1. DGPC shall have the right to propose, and subsequently require, that the Project Manager order the Contractor from time to time during the performance of the Contract to make any change, modification, addition/alteration or deletion to, in or from the Works in the form, quantity or quality of the Works or any part thereof (hereinafter called "Change"), provided that such Change falls within the general scope of the Works and does not constitute unrelated work and that it is technically practicable, taking into account both the state of advancement of the Works and the technical compatibility of the Change envisaged with the nature of the Works as specified in the Contract. Such changes shall include but not limited to the following:

- a. increase or decrease in the quantity of any work included in the Contract;
- b. omission or substitution of any work;
- c. change the drawings, designs specifications, character or quality or kind of any work;
- d. change the levels, lines, positions and dimensions of any part of the Works;



- e. execution of additional work of any kind necessary for the completion of the Works;
- f. change in any specified sequence, method or timing of construction of any part of the Works.

No such changes shall in any way vitiate or invalidate the Contract. The Contractor shall be bound to carry out the works in accordance with such instructions as may be given to him in writing by the Project Manager. However, the value, if any, of all such Change shall be taken into account in ascertaining the amount of the Contract Price.

- GCC.28.1.2. The Contractor may from time to time during its performance of the Contract propose to DGPC (with a copy to the Project Manager) any Change that the Contractor considers necessary or desirable to improve the quality, efficiency or safety of the Works. DGPC may at its discretion approve or reject any Change proposed by the Contractor.
- GCC.28.1.3. Notwithstanding GCC.28.1.1 and GCC.28.1.2, no change made necessary because of any default of the Contractor in the performance of its obligations under the Contract shall be deemed to be a Change, and such change shall not result in any adjustment of the Contract Price or the Time for Completion.
- GCC.28.1.4. The Contractor shall be under obligation to agree for the Changes as may be required during the execution of the Contract as per directions of the Project Manager and execute such changes at the same rates included in the Contract, provided the total effect of such changes does not exceed the limit of plus/minus twenty percent (+-20%) of the Contract Price. Such a ceiling will however be applicable only for items of work/supply for which rates are provided in the Contract. Notwithstanding the aforesaid provision, the quantities for individual items, if specified in the Contract, can vary to any extent. No claim for revision of rates for any individual item in the Bill of Quantities shall be admissible irrespective of the extent to which the ordered quantity may get revised (+) or (-) during the actual execution of the Works. For Change beyond twenty percent (20%) of the Contract Price, the adjustment in the rates for Bill of Quantity items shall be made as per GCC.28.4.
- GCC.28.1.5. The procedure on how to proceed with and execute Changes is specified in GCC.28.2 and GCC.28.3.
- GCC.28.2. **Changes originating from DGPC**
- GCC.28.2.1. If DGPC proposes a Change pursuant to GCC.28.1.1, it shall send to the Contractor a "Request for Change Proposal," requiring the Contractor to prepare and furnish to the Project Manager as soon as reasonably practicable a "Change Proposal," which shall include the following:
 - a. brief description of the Change;
 - b. effect on the Time for Completion;
 - c. estimated cost of the Change;
 - d. effect on any other provisions of the Contract.



GCC.28.2.2. The pricing of any Change shall, as far as practicable, be calculated in accordance with the rates and prices included in the Contract. If the rates and prices of any Change are not available in the Contract, the rates for such items as far as practicable shall be derived from the analogous/similar items in the Bill of Quantities. The decision to select analogous/similar items shall be taken by the Project Manager, which shall be conclusive and binding on the Contractor. In cases where analogous/similar items are not available in the Bill of Quantities, such items shall be treated as extra items. The rates for extra items shall be determined as per **GCC.28.4.2.**

GCC.28.3. Changes originating from Contractor

GCC.28.3.1. If the Contractor proposes a Change pursuant to **GCC.28.1.2**, the Contractor shall submit to the Project Manager a written “Application for Change Proposal,” giving reasons for the proposed Change and including the information specified in **GCC.28.2.1.**

GCC.28.4. Adjustment of the Contract Price

GCC.28.4.1. If reduction or increase in the Contract Price due to Change is found to be more than twenty percent (20%) of the Contract Price, the Contract Price shall be adjusted as per the rates below:

Variation in value of work	Increase in payment for minus variation	Decrease in payment for plus variation
Upto 20%	Nil	Nil
Above 20% & up to 35%	6.00%	3.00%
Above 35% & up to 60%	8.00%	4.00%
Above 60% & up to 100%	10.00%	5.00%
Above 100%	-	5.00%

While working out the value of work for the purpose of variation, the extra items for which new rates have been paid and payment towards price adjustment; and the adjustment towards statutory variations shall not be considered.

Illustration

- a. In case of variation in value of work by (plus) + sixty percent (60%), the payment for (60-20) percent, i.e. forty percent (40%) of value of work shall be decreased by four percent (4%). The reduction in Contract rates shall commence as soon as the value of work executed reaches 120% of Contract Price.
- b. In case of variation in value of work by (minus) – fifty-five percent (55%), the payment for (55-20) percent i.e., thirty-five percent (35%) of value of work shall be increased by eight percent (8%).

GCC.28.4.2. The Contractor within fifteen (15) days from the receipt of an order to execute any extra item shall submit rate analysis to the Project Manager supported by documentary evidence of basic rates adopted therein; having regard to the cost of materials, actual wages of labour, and other operational costs. The analysis so provided by the Contractor shall form the basis for determination of rates for such



extra items. Extra items of work/supply which are not provided in the Bill of Quantities shall be paid on the basis of Bhutan Schedule of Rates (BSR) after adjusting such rates for the place of Works and time period elapsed after the date of BSR. If rates for such extra items are not available in BSR, the rates for such items shall be determined based on the actual expenditure relating to that item including cost of materials, fabrication/machinery handling and erection at Site plus twenty five percent (20%) towards overheads including profits. The price of varied items determined by the Project Manager shall be final and binding on the Contractor. No payment shall be made for the items of Works ordered to be omitted.

GCC.28.4.3. If there is delay in DGPC and the Contractor coming to an agreement on the rate of varied work, provisional rates at the rate of seventy-five percent (75%) of the rates as determined by DGPC will be payable till such time as the rates are finally determined. In any case, DGPC shall decide the rates within a maximum period of forty-five (45) days from the date of submission for the analysis of rates by the Contractor.

GCC.28.4.4. Items of works for which rates have been derived as per GCC.28.2.2 shall be eligible for price adjustment as per the price adjustment formula with base date as per the Contract. Rates for extra items, derived as per GCC.28.4.2 above, shall be eligible for price adjustment as per the price adjustment formula with base date corresponding to the date of input costs considered for working out the rates.

GCC.28.5. **Day Work**

GCC.28.5.1. For work of a minor or incidental nature not covered in the Bill of Quantities, the Project Manager may instruct that a Change shall be executed on a daywork basis.

GCC.28.5.2. The Contractor shall deliver each day to the Project Manager accurate statements in duplicate which shall include the following details of the resources used in executing the previous day's work:

- a. the names, occupations and time of Contractor's employees,
- b. the identification, type and time of Contractor's Equipment and temporary works, and
- c. the quantities and types of plant and materials used.

GCC.28.5.3. One copy of each statement will, if correct, or when agreed, be signed by the Project Manager and returned to the Contractor. The Contractor shall then submit priced statements of these resources to the Project Manager for further approval and inclusion in the next running bill for payment.

GCC.28.6. **Record of costs**

GCC.28.6.1. In any case where the Contractor is instructed to proceed with a variation prior to the determination of the adjustment to the Contract Price in respect thereof, the Contractor shall keep records of the cost of undertaking the variation and of time expended thereon. Such records shall be open to inspection by the Project Manager at all reasonable times.



GCC.29. Termination

- GCC.29.1. The DGPC or the Contractor by giving thirty (30) days written notice of default to the other party, may terminate the Contract in whole or in part if the other party causes a fundamental breach of Contract.
- GCC.29.2. Fundamental breaches of the Contract shall include, but shall not be limited to, the following:
- a. the Contractor stops work for more than thirty (30) days when no stoppage of work is shown on the current Programme and the stoppage has not been authorized by the Engineer;
 - b. the DGPC gives notice that failure to correct a particular defect is a fundamental breach of Contract and the Contractor fails to correct it within a reasonable period of time determined by the Engineer;
 - c. the Contractor has delayed the completion of the Works by the number of days for which the maximum amount of Liquidated Damages can be paid;
 - d. the Contractor, in the judgment of the DGPC, has engaged in corrupt or fraudulent practices, as defined in GCC Clause 5, in competing for or in executing the Contract; and
 - e. a payment certified by the Engineer is not paid to the Contractor by the DGPC within sixty (60) days of the date of the Engineer's certificate;
 - f. If DGPC does not provide the site by the date specified or the extended date if any.
- GCC.29.3. DGPC and the Contractor may at any time terminate the Contract by giving notice to the other party if either of the parties becomes bankrupt or otherwise insolvent. In such event, termination will be without compensation to any party provided that such termination will not prejudice or affect any right of action or remedy that has accrued or will accrue to the other party.
- GCC.29.4. Notwithstanding the above, the DGPC may terminate the Contract for convenience.
- GCC.29.5. If the Contract is terminated, the Contractor is to stop work immediately, make the Site safe and secure and hand over the Site to the DGPC as soon as reasonably possible.

GCC.30. Payment upon Termination

- GCC.30.1. If the Contract is terminated because of a fundamental breach of Contract by the Contractor, the Engineer shall issue a certificate for the value of the work done.
- GCC.30.2. If the Contract is terminated for the DGPC convenience or because of a fundamental breach of Contract by the DGPC, the Contractor shall be entitled to payments for completed works and the materials that have been brought to the Site for the purpose of the Works, but not used as certified by the Engineer after adjusting any payments received by the Contractor.



GCC.31. Sub- Letting

GCC.31.1. The Contractor shall not sublet, transfer or assign any part of this contract, without the prior written consent of the DGPC. Such assignments or sub-letting or transfer shall not relieve the Contractor from any obligation, duty and responsibility under this contract. Any assignment, transfer or sub-letting without the prior written approval of the DGPC shall be void. The DGPC shall have the right to cancel the contract and get the work done from any other party and the Contractor shall be liable to the DGPC for any loss or damage which the DGPC may sustain in consequence or arising out of such work and the Contractor shall indemnify such loss or damage to the DGPC.

GCC.32. Taking Over

GCC.32.1. DGPC shall take over the Site and the Works and shall issue the Completion Certificate within 7 days of taking over. The completion certificate shall include the following mandatory information:

- a. Name of Contract firm;
- b. Name of Proprietor;
- c. CDB Registration No.;
- d. Trade License No.;
- e. Contract Amount;
- f. Year of Completion;
- g. Award order No. with Date.

GCC.33. Settlement of Disputes

GCC.33.1. The Employer and the Contractor shall use their best efforts to settle amicably all disputes arising out of or in connection with this Contract or its interpretation.

GCC.33.2. Any dispute between the parties to the Contract that may not be settled amicably will be referred to Arbitration at the initiative of either of the parties.

GCC.33.3. The Arbitration shall be conducted in accordance with the Arbitration Rules of the Kingdom of Bhutan in force.



SECTION V- SPECIAL CONDITIONS OF CONTRACT



SECTION V- SPECIAL CONDITIONS OF CONTRACT

GCC Clause Reference	Amendments of, and Supplements to, Clauses in the General Conditions of Contract									
GCC.12.1	For insurance purposes, the type of cover required shall be: The contractor shall be responsible for the insurance									
GCC.13.1 and GCC.17.1	Possession of the site shall be within [15] days from the date of signing of the Contract.									
GCC.14.1	Commencement of work shall be within [15] days from the date of handing over possession of the Site.									
GCC.15.1	The Bidder shall be required to complete the work within 6 months from the date of Letter of Award (LoA).									
GCC.16.1	<p>The Contractor shall submit the first work plan [7] days after signing the contract, and shall update the work plan every [3] week during the period of the Contract.</p> <p>The amount to be deducted for the key personnel not employed by the contractor for each personnel is:</p> <table border="1" data-bbox="437 927 1217 1155"> <thead> <tr> <th data-bbox="437 927 523 1077">Sl. No.</th> <th data-bbox="523 927 804 1077">Manpower</th> <th data-bbox="804 927 1217 1077">Deduction Amount (per day) BTN</th> </tr> </thead> <tbody> <tr> <td data-bbox="437 1077 523 1155">1</td> <td data-bbox="523 1077 804 1155">Site Supervisor</td> <td data-bbox="804 1077 1217 1155">500.00</td> </tr> </tbody> </table>	Sl. No.	Manpower	Deduction Amount (per day) BTN	1	Site Supervisor	500.00			
Sl. No.	Manpower	Deduction Amount (per day) BTN								
1	Site Supervisor	500.00								
GCC.20.1	Terms of Payment to: The Contractor shall be entitled to secured advance against the procurement of materials for this Contract.									
GCC.22.1 and GCC.22.2	<p>The Works or part of Works that can be subcontracted and the qualifying requirement for the selection of Subcontractors to perform such part are: (Not Applicable)</p> <table border="1" data-bbox="392 1368 1155 1688"> <thead> <tr> <th data-bbox="392 1368 523 1518">Sl.No.</th> <th data-bbox="523 1368 874 1518">Part of the Works which can be subcontracted</th> <th data-bbox="874 1368 1155 1518">Qualification requirement of Subcontractor</th> </tr> </thead> <tbody> <tr> <td data-bbox="392 1518 523 1601"></td> <td data-bbox="523 1518 874 1601"></td> <td data-bbox="874 1518 1155 1601"></td> </tr> <tr> <td data-bbox="392 1601 523 1688"></td> <td data-bbox="523 1601 874 1688"></td> <td data-bbox="874 1601 1155 1688"></td> </tr> </tbody> </table>	Sl.No.	Part of the Works which can be subcontracted	Qualification requirement of Subcontractor						
Sl.No.	Part of the Works which can be subcontracted	Qualification requirement of Subcontractor								
GCC.24.1	Liquidated Damages shall be a sum equivalent to the percentage 0.20% of the Contract Price for each day of delay, up to a maximum deduction of ten (10%) percentage of the Contract Price.									



SECTION VI - TECHNICAL SPECIFICATIONS



TECHNICAL SPECIFICATION

1.Scope of Works

The work to be carried out under the Contract as specified in the contract document, drawings and shall include the following:

- Earth Works
- RRM works
- Bricks works
- Concrete works
- Plastering works
- Aluminum works
- Steel works
- Roofing works
- Painting works
- Drainage works

All works shall be undertaken on the basis of an item rate contract.

2.Technical Specification

Civil Works:

The work shall be executed in accordance with the “Specifications for Building and Road Works (SBRW)-2023 and the materials to be used shall be as per the certified/approved brand given in Bhutan standard Bureau (BSB). The contractor shall submit samples of all the civil materials for approval from client before mobilization of materials at site or client shall accompany contractor for inspection of materials in the market.

Electrical work:

The work shall be executed in accordance with the “Specifications of Electrical Works” (SEW)-2022.The brand of electrical shall be the brands approved by Bhutan standard Bureau (BSB). For those materials which are not reflected in the BSB, the contractor shall provide sample of the proposed materials to be supplied for approval of the employer before execution of the work.

Health and safety Measures:

The use of appropriate respiratory protection, safety belts, safety boot and hand gloves are recommended. The Health and Safety advice on packaging labels must be observed. Labours should attend the health and safety talks given by the client from time to time.



1. Drawings

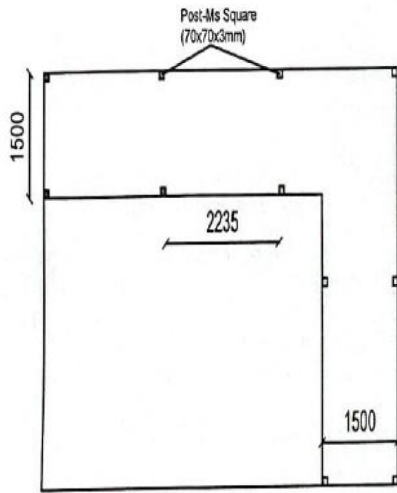

LAYOUT PLAN

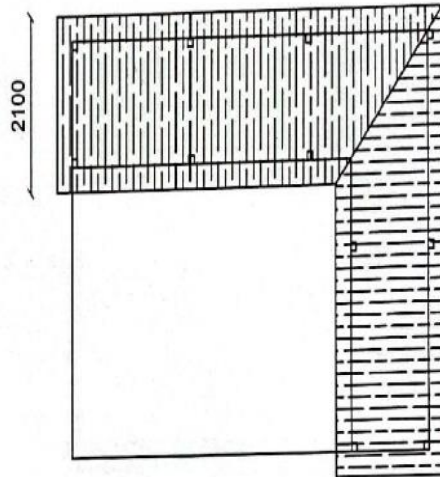

ROOF PLAN

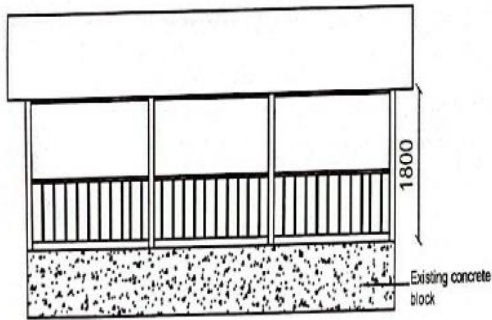

BACK ELEVATION

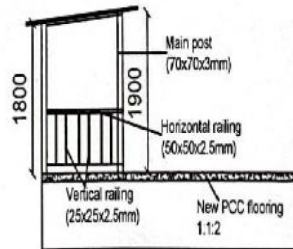

SIDE ELEVATION

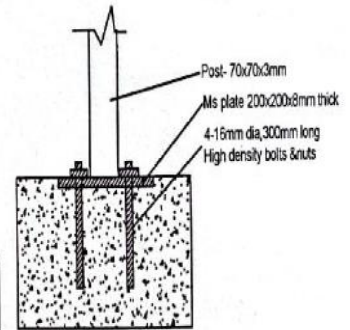

BASE PLATE & ANCHOR DETAIL

KURICHHU HYDROPOWER PLANT, DGPCL

TITLE: BOAT DOCK CANOPY

All dimensions are in mm

NAME OF WORK: Construction of Canopy at Boat dock

Drawn By: *[Signature]*
Sonam Dorji, S.S.O

Checked By: *[Signature]*
Tandin Wangchuk, Head, CMU

Approved By: *[Signature]*
Rinchen Wangdi, N.O.P

SCALE: NTS

DATE: March, 2024

PAGE No: 01



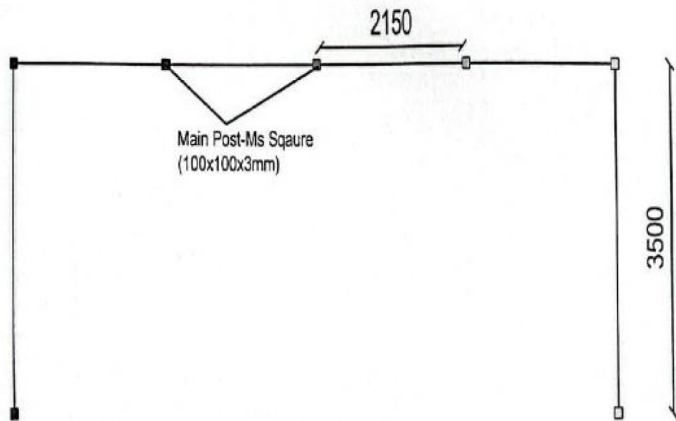

LAYOUT PLAN

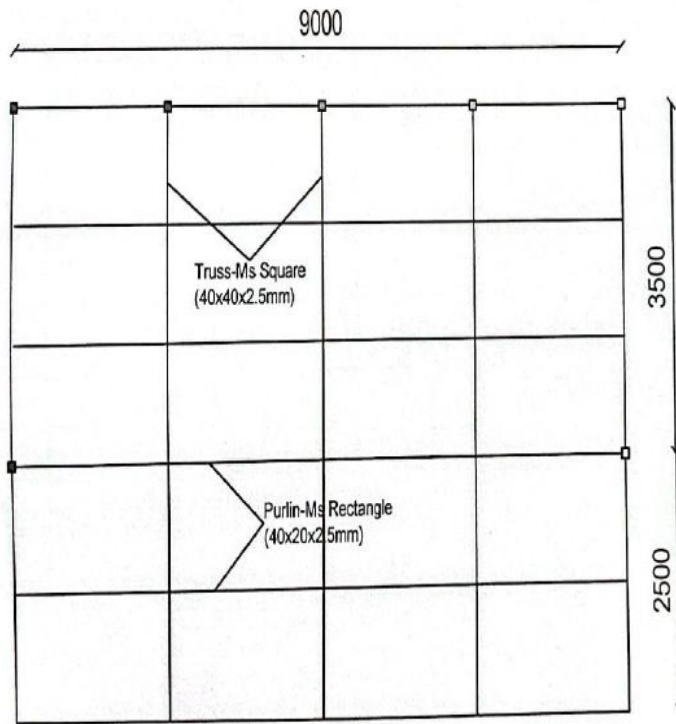

TRUSS LAYOUT

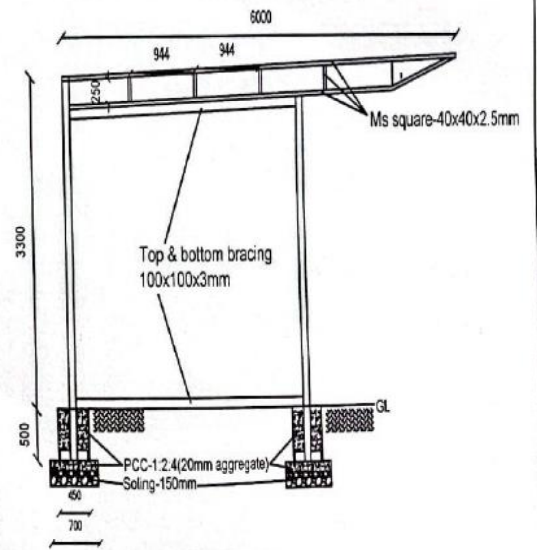

POST & TRUSS SECTION

All dimensions are in mm

KURICHHU HYDROPOWER PLANT, DGPCCL

TITLE: BOAT DOCK

SCALE NTS

NAME OF WORK: Construction of VVIP Boat Shed

Drawn By
Sonam Dorji, Sr.S/O

Checked By
Tandin Wangchuk, HOP, CMU

Approved By
Rinchen Wangdi, HOP

DATE March, 2024

PAGE No 01



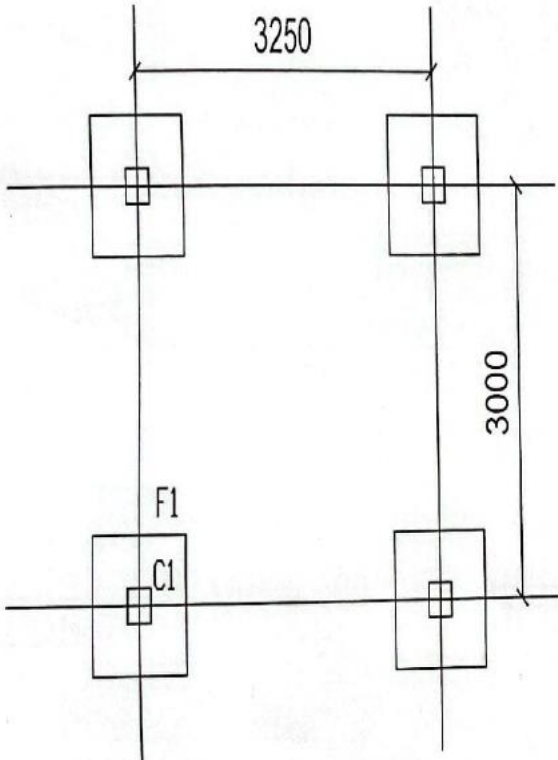

FOUNDATION LAYOUT PLAN

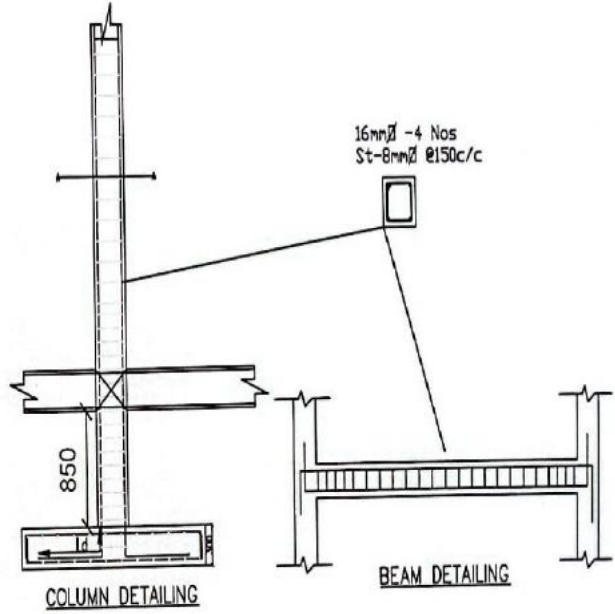

SCHEDULE FOR COLUMN

SL.NO	COLUMN	SIZE	REINFORCEMENTS
			LONGITUDINAL
1	C1	250x250	4-16Ø

KURICHHU HYDROPOWER PLANT, DGPCL	TITLE: STORE		All dimensions are in mm	
	NAME OF WORK: Construction of Store at Boat Dock	Drawn By: <i>[Signature]</i> Sonam Dorji, Sr S O	Checked By: <i>[Signature]</i> Tandin Wangchuk, Head CMU	Approved By: <i>[Signature]</i> Rinchen Wangpa, EOP
			DATE: March, 2024	
			PAGE No: 01	



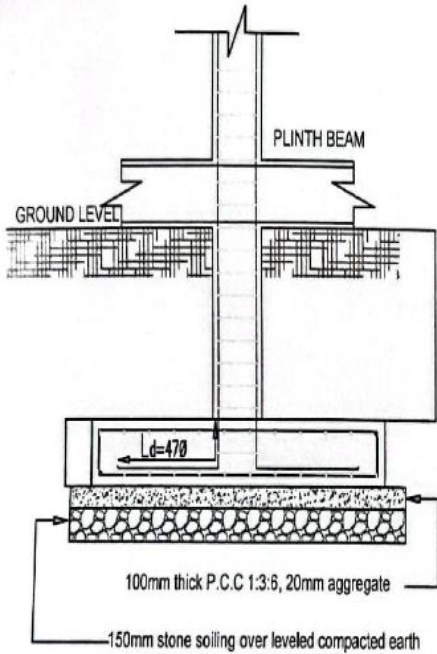

SECTIONAL ELEVATION FOR FOOTING

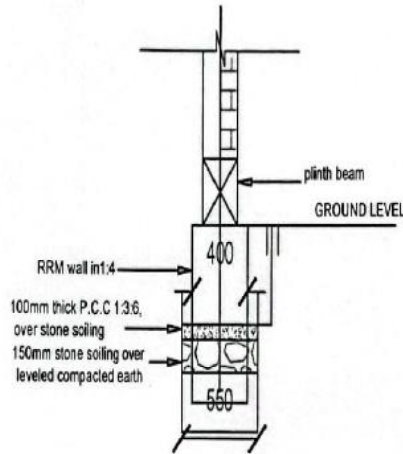

EXTERNAL WALL (250mm) FOUNDATION

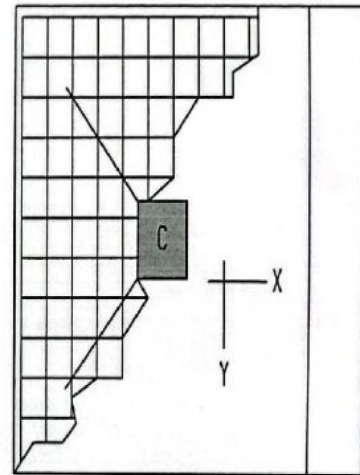

FOOTING DETAILS

SCHEDULE OF FOOTINGS

SL/NO	FOOTINGS TYPE	FOOTING SIZE		BOTTOM REINFORCEMENTS		TOP REINFORCEMENTS		DEPTH OF FOUNDATION(DF)
		LENGTH(Lx)	WIDTH(Ly)	X-DIRECTION	Y-DIRECTION	X-DIRECTION	Y-DIRECTION	
F1	ISOLATED FOOTING	1000	1000	10#@150mmc/c	10#@150mmc/c	10#@150mmc/c	10#@150mmc/c	1350MM

KURICHHU HYDROPOWER PLANT, DGPCL	TITLE:STORE			All dimensions are in mm	
				SCALE	NTS
NAME OF WORK: Construction of Store at Boat Dock	Drawn By Sonam Dorji, Sr S/O	Checked By Tandin Wangchuk, Head, ENU	Approved By Rinchen Wangchuk	DATE	March, 2024
				PAGE No	02



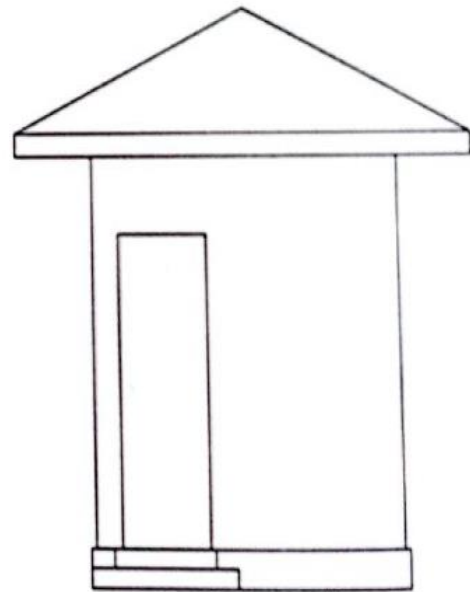
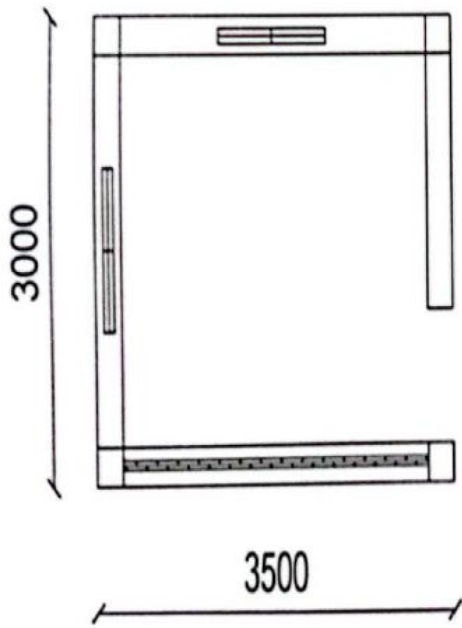
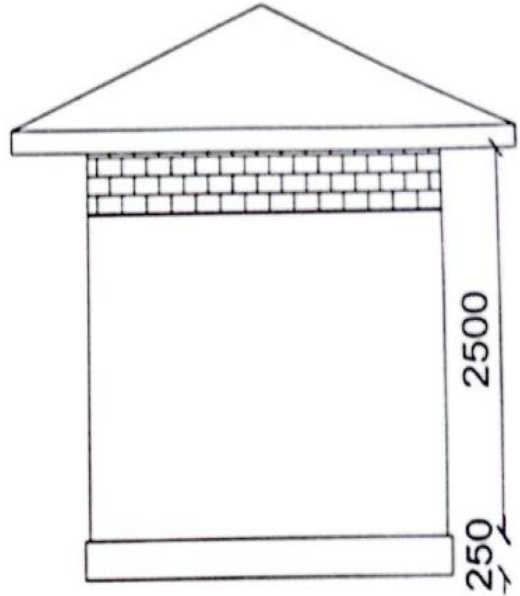
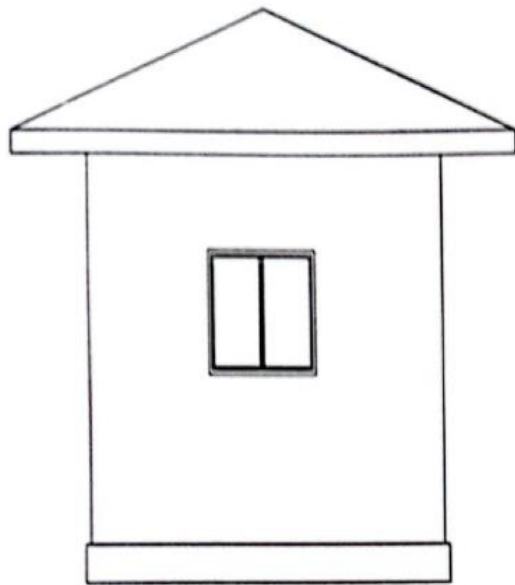

KURICHHU HYDROPOWER PLANT, DGPCL	TITLE: STORE			All dimensions are in mm	
				SCALE	NTS
NAME OF WORK: Construction of Store at Boat Dock	Drawn By	Checked By	Approved By	DATE	March, 2024
	Sonam Dorji, Sr S/O	Tandin Wangchuk, Engineer	Rinchen Wangchuk, DC	PAGE No	05



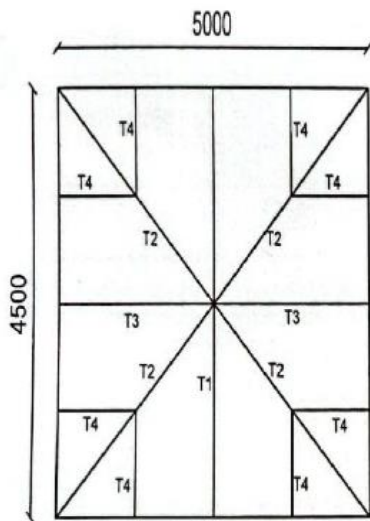

TRUSS LAYOUT

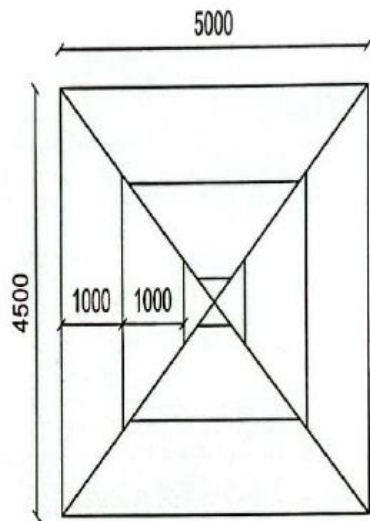

PURLIN LAYOUT

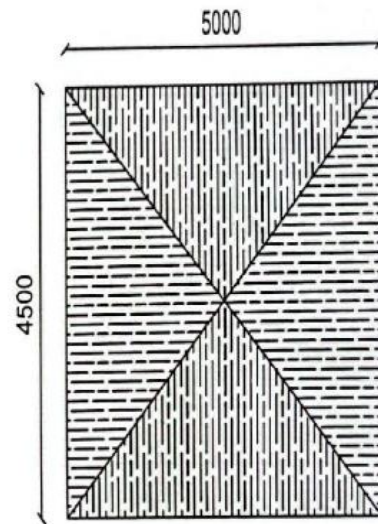

ROOF LAYOUT

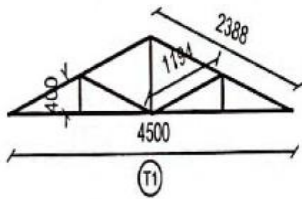

T1

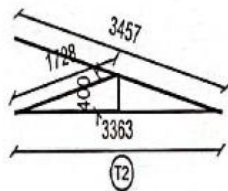

T2

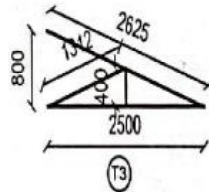

T3

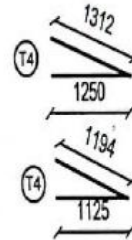

T4

T4

KURICHHU HYDROPOWER PLANT, DGPCCL

TITLE: STORE

All dimensions are in mm

NAME OF WORK: Construction of Store at Boat Dock

Drawn By: *[Signature]*
Sonam Dorji, Sr.S.O

Checked By: *[Signature]*
Tandin Wangchuk, Head, CMU

Approved By: *[Signature]*
Runchen Wangdi, HCP

SCALE	NTS
DATE	March, 2024
PAGE No	04



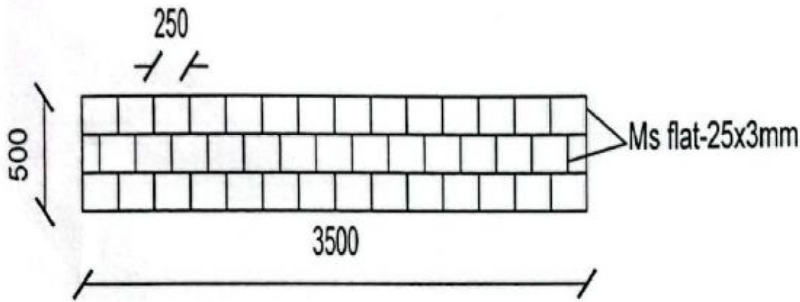

Ventilation Grill

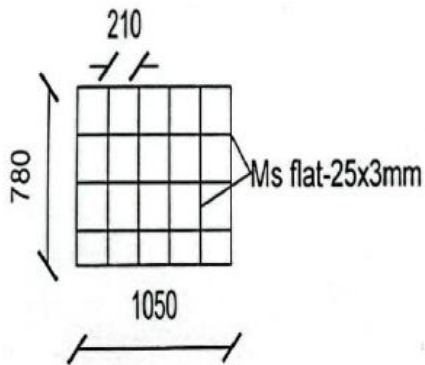

Window Grill

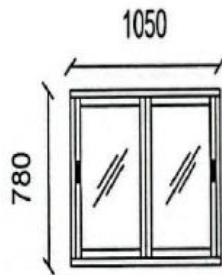

Window

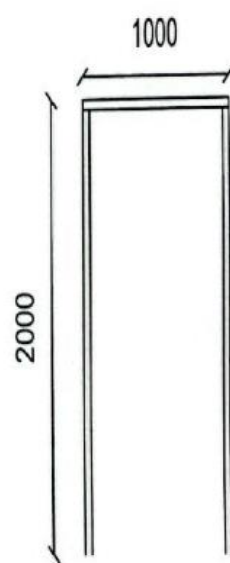

Door Frame

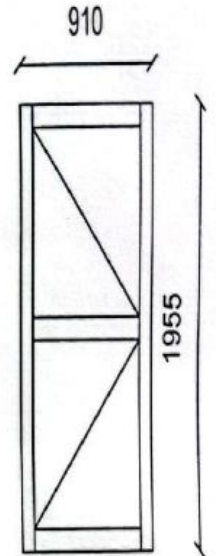

Door shutter

KURICHHU HYDROPOWER PLANT, DGPCCL	TITLE:STORE			All dimensions are in mm	
				SCALE	NTS
NAME OF WORK: Construction of Store at Boat Dock	Drawn By: <i>[Signature]</i> Sonam Dorji, Sr SO	Checked By: <i>[Signature]</i> Tandin Wangchuk, HOD, MU	Approved By: <i>[Signature]</i> Rinchen Wangdi, HOD	DATE	March 2024
				PAGE No	05



SECTION VII- CONTRACT FORM

Form 1: Contract Agreement

THIS AGREEMENT, made the [day] of [month] [year] between [name and address of DGPC] (hereinafter called “the DGPC”) of the one part and [name and address of Contractor] (hereinafter called “the Contractor”) of the other part.

WHEREAS, the DGPC invited Tenders for certain Works, viz, [brief description of the Works] and has accepted a Tender by the Contractor for the execution of those works in the sum of Ngultrum [insert amount in figures and words], hereinafter called “the Contract Price.

NOW THIS AGREEMENT WITNESSETH as follows:

1. In this Agreement, words and expressions shall have the same meanings as are respectively assigned to them in the General Conditions of Contract hereinafter referred to.
2. The documents forming the Contract shall be interpreted in the following order of priority:
 - (a) The signed Contract Agreement;
 - (b) Letter of Award;
 - (c) The completed Bid form as submitted by the Bidder;
 - (d) The Special Conditions of Contract;
 - (e) The General Conditions of Contract;
 - (f) Specifications
 - (g) The Drawings; and
 - (h) Any other document listed in the SCC as forming part of the Contract.
3. In consideration of the payments to be made by the DGPC to the Contractor as hereinafter mentioned, the Contractor hereby covenants with the DGPC to execute and complete the Works and to remedy any defects therein in conformity in all respects with the provisions of the Contract.
4. The DGPC hereby covenants to pay the Contractor in consideration of the execution and completion of the Works and the remedying of defects therein, the Contract Price or such other sum as may become payable under the provisions of the Contract at the times and in the manner prescribed by the Contract.

IN WITNESS whereof the Parties thereto have caused this Agreement to be executed in accordance with the laws of Bhutan on the day month and year is first before written.

	For the DGPC	For the Contractor
Signature		
Print Name		
In the presence of (Name)		



Form 2: Letter of Award of Contract

Dear Sirs,

This is to notify you that your Bid dated..... for execution of the
..... [Name of the Contract and Tender No., as given
in NIT] for the Contract Price of [amount in
words and figures as corrected and modified in accordance with the ITB] is hereby accepted by
DGPC.

The successful bidder shall return one copy of the Letter of Award to DGPC after duly recording
“Accepted Unconditionally” under the signature of the authorised signatory within seven (7)
days of the date of Letter of Award

You are hereby requested to commence the work and sign the Contract within fifteen (15) days
of the receipt of this Letter of Award.

Failure to commence the work within the period stipulated above shall constitute a ground for
the annulment of the award and entail forfeiture of Bid Security.

Please acknowledge receipt.

Yours faithfully,

Signature



SECTION VIII- PERFORMANCE EVALUATION SYSTEM



SECTION VIII - PERFORMANCE EVALUATION SYSTEM

1. INTRODUCTION

A contractor performance evaluation is a standardized, systematic and objective assessment of a contractor's performance on a specific project contract. This enables DGPC to judge whether the contractor has performed the work to a high standard on a number of fronts, and whether it is worth engaging them for future projects.

The performance evaluation criteria shall be used by each Project Manager/Site Engineer immediately with the commissioning of any work or services after the award of contract. The contractors shall be evaluated as the work progresses.

2. OBJECTIVES

The main objectives of the performance evaluation of Contractors for works are as follows:

- To adopt a more holistic approach in reviewing overall performance of Contractor;
- To work with Contractor to raise safety and quality standards;
- To encourage an environment of continuous improvement by Contractor;
- To build partnership with Contractor in specific and strategic areas; and
- To have a list of preferred Contractor to be selected for limited bidding process

3. PERFORMANCE EVALUATION SYSTEM (PES)

The assessment of the Contractors shall be done as follows:

SN	Particulars	Score
3.1	Pre-construction	10%
3.2	Construction	80%
3.2.1	<i>Administration</i>	30%
3.2.2	<i>Safety</i>	10%
3.2.2	<i>Quality</i>	40%
3.3	Completion Time	10%
Total		100%

3.1 Pre-construction (10%)

SN	Particulars	Score	Key performance measurement	Remarks
3.1.1	Work Schedule	2%	On time submission =100% or else 0%	Reference to be taken from the kick off meeting, which must be held before the start of the work.
3.1.2	Method Statement/ Methodology	2%	Submitted on time and agreeable =100% After 1 st revision= 80%	As submitted along with the bid.



			After 2 nd revision= 50% After 3 rd revision= 0%	Revision would mean, the methodology submitted does not suffice the requirement.
3.1.3	Mobilization	2%	Early= 120% On time= 100% Late= 0%	
3.1.4	Quality Assurance Plan (QAP)	2%	Submitted on time and agreeable =100% After 1 st revision= 80% After 2 nd revision= 50% After 3 rd revision= 0%	As submitted along with the bid.
3.1.5	Insurance certificate	2%	Submitted within 15 days of Contract Award= 100% Submitted along with 1 st RA Bill =50%	Date to be considered from the signing of contract agreement

3.2 Construction (80%)

3.2.1 Administration (30%)

SN	Particulars	Score	Key performance measurement	Remarks
3.2.1.1	Timely commencement	5%	✓ Early= 120% ✓ On time= 100% ✓ Late= 0%	As per the contract Agreement
3.2.1.2	Deployment of manpower and machineries (as per contract)	2%	✓ Deployed as per schedule= 100% ✓ Not as per schedule= 0%	Reference to be considered from the Contract Agreement
3.2.1.3	Deployment of additional manpower and equipment for specific activities	5%	✓ As per schedule = 100% ✓ 80% deployment = 80% ✓ 50% deployment = 50% ✓ Below 50% deployment = 0%	✓ Based on work schedule/ Works Program ✓ Determined by the implementing agency. ✓ Based on monthly reports
3.2.1.4	Key construction materials arrangement	5%	Adequate and timely = 100% or else 0%	Based on the Review report and agreed by both the parties.
3.2.1.5	Joint measurement	2%	Full attendance of contractor's representative =100% or else 0%	Based on the written request made by the Project Manager/Site Engineer considering the convenient time of both the parties.



3.2.1.6	Accuracy of running bills	3%	Accurate=100% Good (has few errors)= 60% Poor (frequently misrepresents the actual work and has multiple errors)= 0%	Accuracy of the bills submitted by the Contractor shall be assessed.
3.2.1.7	Timely Progress Report submission	2%	✓ 80% and above compliance = 100% ✓ Above 50% and up to 80% = 50% ✓ Below 50% = 0%	Reference to be taken from Kick off meeting.
3.2.1.8	Cooperation and Coordination with Employer	2%	✓ Excellent (proactive and prompt)=100% ✓ Good (needs to be prompted by the client)= 80% ✓ Poor=0%	To be rated on the promptness of the Contractor on resolution of any issue and on following the guidelines set in the Contract Document. Also on the communication, returning of phone calls or replying of emails.
3.2.1.9	Meetings (Progress Review Meetings, Coordination Meetings, etc)	2%	Full attendance of contractor's representative = 100% or else 0%	Based on the written request made by the Project Manager/Site Engineer considering the convenient time of both the parties.
3.2.1.10	Payment to labour, sub-contractors and suppliers	2%	✓ Less than 3 written complains = 100% ✓ Above 3 written complaints = 0%	Based on the written complaints by labour or sub-contractors or suppliers

3.2.2 Safety (10%)

SN	Particulars	Score	Key performance measurement	Remarks
3.2.2.1	Site Safety management (Signage/Barriers/ housekeeping/PPE/ others*)	4%	✓ 100% compliance = 100% ✓ 80% compliance = 50%	The Safety requirement to be specified in the Kick off meeting and according make the



			<ul style="list-style-type: none"> ✓ Less than 80% = 0% 	assessment based on the same.
3.2.2.2	Safety awareness and orientation	2%	<ul style="list-style-type: none"> ✓ Monthly = 100% ✓ Quarterly = 50% 	Assessment to be made based on the attendance sheet and report submitted by the designated Safety Officer of the contractor.
3.2.2.3	Safety Officer/Safety Supervisor	2%	<ul style="list-style-type: none"> ✓ Appointed = 100% ✓ Not appointed = 0% 	Designated safety officers need to be identified and mentioned in the kick off meeting.
3.2.2.4	Accident	2%	<ul style="list-style-type: none"> ✓ Zero CDL = 100%. ✓ Up to 2 incidences = 80% ✓ More than 2 incidences = 0% 	Accident would mean an accident that would result in absence from the work.

Note: *Separate list would be prepared considering the risk and safety aspects of the work (based on the nature of work). The list to be finalized before the start of the work (during the kick off meeting) and it shall be in line with the safety requirements specified by MoLHR.

3.2.3. Quality (40%)

SN	Particulars	Score	Key performance measurement	Remarks
3.2.3.1	Compliance to Drawings/Specifications/ methodology	13%	<ul style="list-style-type: none"> ✓ Strict adherence =100% ✓ With minor deviations= 80% ✓ Frequent non-compliance= 0% 	<ul style="list-style-type: none"> ✓ Minor deviations would mean deviations which does not lead to major issues to the project. ✓ Frequent non-compliance would mean non-compliance leading to delays.
3.2.3.2	Inspections	5%	<ul style="list-style-type: none"> ✓ 80% compliance = 100% ✓ Below 80% compliance = 0% 	To be measured based on written request (adequate inspection time to be provided and full attendance of contractor's representative).
3.2.3.3	Implementation of QAP (Test reports to be submitted, where necessary)	12%	<ul style="list-style-type: none"> ✓ Implementation (60%) = 100% or else 0% ✓ Test reports submission (40%) = 100% or else 0% 	



3.2.3.4	Response to Non-compliance, Complaints and Notices	5%	<ul style="list-style-type: none"> ✓ 100% response = 100% ✓ 80% response = 80% ✓ Less than 80% response = 0% 	Calculation will be based on the number of requests made by the Project Manager/Project Engineer.
3.2.3.5	Documentation	5%	<ul style="list-style-type: none"> ✓ Outstanding=100% ✓ Marginal (omissions of submittals resulting in errors and leading to revision of the schedule) =50% ✓ Unsatisfactory = 0% 	The documentation to be submitted by the contractor based on the schedule and as agreed during the kick off time.

3.3 Completion Time (10%)

SN	Particulars	Score
3.3.1	Completion	Early=120% On time= 100%
3.3.2	Delay up to 20%	80%
3.3.3	Delay > 20%	0%

4. Contractor Assessment Category

The Contractors shall be categorized into three categories as under:

Category	Score	Remarks
A	80-100	Recommended/Preferred Contractors
B	50-79	<ul style="list-style-type: none"> ✓ Contractors must be developed; ✓ Consider, but with mandatory debriefing on the shortcomings.
C	0-49	Contractors not qualified

5. EVALUATION PERIOD AND DEBARMENT

5.1. Evaluation period

The Performance evaluation shall be carried out after the commencement of any project till its closure.

5.2. Debarment of Contractors

Based on the assessment of contractors at the closure of each project, all non-performing Contractors shall be referred to the Debarment Committee as per the Debarment Rules 2019 of RGoB. The non-performing contractor falling under category B and C shall be subjected to referral to the Debarment Committee and the decision of the Committee shall be final and binding.

